

2020

SIGSAUER[™]
NEVER SETTLE

PRODUCT CATALOG

TABLE OF CONTENTS

SIG SAUER[™]
NEVER SETTLE

SIG SAUER[®], Inc. • 72 Pease Boulevard • Newington, NH 03801 USA • +1 (603) 610-3000

An ISO 9001:2015 Registered Company. Manufacturing in the U.S.A.

All trademarks, service marks, trade names, trade dress, product names and logos appearing in this catalog are the property of their respective owners.
No trademark or service mark appearing in this catalog may be used without the prior written consent of the owner.

INTRODUCTION 2

EVOLUTION OF SIG 3

CONTRACTS/AWARDS 4

PISTOLS 6

RED DOT REVOLUTION 10

P365 12

P320 14

P30 M17 / M18 16

P320 XSERIES 18

P320 RXP 20

P320 MODULAR HANDGUN 22

SP2022 24

P226 26

P229 28

P220 30

1911 32

P238 34

P938 36

P210 38

LEGION SERIES 40

CUSTOM WORKS 46

RIFLES 50

MCX VIRTUS 52

MCX RATTLER 56

MPX 58

716 60

M400 TREAD 62

CROSS RIFLE 66

AMMUNITION 68

ELECTRO-OPTICS 88

SUPPRESSORS 148

AIRGUNS 158

ACADEMY 182

TEAM SIG 188

ACCESSORIES 190

SPECIFICATIONS 196

In our state-of-the-art facilities across eight locations worldwide SIG SAUER® manufactures the finest firearms, electro-optics, ammunition, suppressors, and airguns, while also offering world-class firearms and tactical training at the SIG SAUER AcademySM.

At SIG SAUER we are driven by our relentless pursuit to manufacture products of unparalleled quality, an unwillingness to compromise, and an absolute refusal to settle. We are emboldened by our love of freedom and share the same passion and pride for our country as those who choose the SIG SAUER brand.

Regardless of whether a SIG SAUER product is being deployed on the battlefield by a soldier, protecting law enforcement as an official duty sidearm, or simply the product of choice of a private citizen, you can trust that if it carries the SIG SAUER name it is built to our precise exacting standards, and undergoes the same rigorous quality controls to ensure that it performs when it matters most.



THE EVOLUTION OF SIG SAUER®

From Wagons to Worldwide Leader

When business entrepreneurs Friedrich Peyer Im Hof, Heinrich Moser, and Conrad Neher opened a wagon factory near the Rhine Falls in Switzerland in 1853, they laid the foundation for what would become the international leader in the small arms industry. Just seven years after constructing an industrial plant for building their wagons and railway cars, the three ambitious owners undertook a new venture responding to a challenge from Switzerland's Federal Ministry of Defense to develop a state-of-the-art rifle in hopes that the Swiss Army would adopt it.

Four years later, the trio found themselves facing an order for 30,000 of their rifles, and changed the name of their company to Swiss Industrial Group. The name was later shortened to SIG as they officially became one of the world's premier firearms manufacturers.

In the 1970's, the SIG small arms division expanded within Europe to include Hammerli Target Arms of Switzerland, and the legendary J.P. Sauer & Sohn, GmbH of Germany – one of Europe's oldest and most prestigious firearms manufacturers.

In the 1980's, SIG set its sights on the United States of America and opened its first American location in Virginia under the name SIGARMS®, and began importing and assembling the company's classic handguns.

In the 1990's, SIGARMS expanded its United States footprint by opening new manufacturing facilities in Exeter, New Hampshire where it would continue to expand to include the world-class SIGARMS training academy in Epping, New Hampshire.

In 2007, SIGARMS officially changed its name to SIG SAUER, aligning the company under a single global brand. Since then SIG SAUER has experienced unprecedented growth and expanded its New Hampshire footprint to include a 206,000 sq./ft. corporate headquarters and advanced manufacturing facility at Pease International Tradeport. SIG SAUER continually invests in workforce development by hiring the foremost industry experts in ever expanding categories to ensure that all SIG SAUER products exceed the quality expectations that are synonymous with the brand.

Today, the SIG SAUER product lineup goes well beyond firearms to include a broad array of products such as electro-optics, ammunition, suppressors, and airguns, all designed, engineered, and manufactured to the same exacting standards of quality, reliability, and performance that have made SIG SAUER the brand of choice for the military, special forces, law enforcement, and civilians across the globe. In addition, SIG SAUER has expanded its U.S operations with a dedicated optics facility in Oregon and a purpose-built ammunition plant in Arkansas.

SIG SAUER has evolved because we continually compete against ourselves, because we believe our greatest success has yet to be engineered, and we are driven by the knowledge that our customers can't afford to settle so they trust we never will. SIG SAUER. Never Settle.

SIG SAUER™
NEVER SETTLE

U.S. DEFENSE CONTRACTS

U.S. Military (All Branches) M17*/M18*

After one of the most rigorous and highly competitive selection processes in the history of small arms, the SIG SAUER® P320® based M17 and M18 were awarded the Modular Handgun System (MHS) contract by the U.S. Army. The M17 and M18 have now been adopted by all branches of the U.S. Military.

U.S. Army Next Generation Squad Weapons (NGSW) Program

SIG SAUER has been selected by the U.S. Army to develop the Next Generation of squad-based weapon systems, including a lightweight machine gun, a carbine rifle, a next generation of suppressor and the first-of-its-kind hybrid ammunition.

U.S. Army Contracting Command .300 Win Mag Ammunition

SIG SAUER Ammunition, known for quality and accuracy, was selected by the U.S. Army to manufacture the Mk 248 MOD 1 and MOD 0 .300 Win Mag ammunition for use in U.S. Military Sniper Platforms.

DOD Suppressed Upper Receiver Group MCX™ (SURG)

The SIG SAUER MCX system was selected to upgrade the existing M4A1 U.S. Special Operations Forces carbines and optimize their weapons for continuous suppressed use on the battlefield.

U.S. Army/DOD/U.S. Air Force TANGO6T SDMR

SIG SAUER Electro-Optics TANGO6T 1-6x24 riflescopes have been selected by both the U.S. Army for their Squad Designated Marksman (SDMR) program as well as U.S. Special Operations Forces for their Squad Variable Powered Scope (SVPS) program. In addition, the U.S. Air Force has selected the TANGO6T for its marksman rifle platforms.

Department of Homeland Security (DHS) P320

After a rigorous selection process the SIG SAUER P320 pistol was chosen as the official duty pistol for DHS Immigration and Customs Enforcement (ICE).

U.S. Coast Guard PROFORCE® P229

SIG AIR® was chosen to supply the U.S. Coast Guard with the SIG AIR PROFORCE P229* airsoft pistol as an official training pistol for Cadets and Guardsmen.



INDUSTRY AND CONSUMER AWARDS

SIG SAUER® is proud to be honored by our peers and have our products recognized for innovation, quality, and capability.

2019 NRA GOLDEN BULLSEYE AWARD

In an unprecedented achievement for one company, SIG SAUER products were honored with three 2019 Golden Bullseye Awards for firearms, ammunition, and electro-optics. Awarded to products on the market, with proven reliability and value to the consumer from various NRA publications.

Shooting Illustrated Handgun of the Year: SIG P365

American Rifleman Product of the Year: SIG 365 Micro 9mm ammunition

American Hunter Optic of the Year: SIG BDX Optics System



2019 INDUSTRY CHOICE AWARDS

Recognizing fit, form, finish, and functionality in firearms by industry peers.

Pistol Caliber Carbine of the Year: SIG MPX PCC

Optic of the Year: KILO3000BDX Rangefinder Binoculars



2019 OUTDOOR LIFE AWARDS

Recognizing versatility in riflescopes.

Editor's Choice, Versatile Riflescopes: WHISKEY5



2019 GOLDEN TRIGGR AWARDS

Recognizing innovation in the firearms industry.

Innovation in Optics: ROMEO8H



2019 NASGW INNOVATOR OF THE YEAR AWARD

Recognizing members of the National Association of Sporting Goods Wholesalers that exemplify a commitment to distribution in the industry.

2019 NASGW-POMA CALIBER AWARD

Recognizing new and innovative products within the sporting goods industry.

Best New Handgun: SIG P365 SAS

2019 THE FIREARMS BLOG BEST COMPACT STRIKER-FIRED PISTOL

A Readers Choice Award given to the SIG P365 Micro-Compact pistol.

2019 ON-TARGET MAGAZINE EDITOR'S CHOICE AWARDS:

Given to the "best-of-the-best" in new guns, optics, gear, and accessories.

Editors Choice: P320 XFIVE LEGION

Editors Choice: Elite Hunter Tipped Ammunition



SIG SAUER
NEVER SETTLE

PISTOLS





PISTOLS

Choose from a full array of sizes, triggers, calibers, finishes, and features—all with unfailing SIG reliability and accuracy.

INSPIRED BY THE ELITE PROFESSIONAL. CARRIED BY ALL WHO DEMAND THE BEST.

Unless it's a SIG, a handgun is just a handgun. Engineered to perform anywhere, at any time, and under any circumstance, SIG pistols boast unique, advanced features that stand out amongst the rest. Key features include:



X-RAY3™ Sights



Integral Accessory Rail



4-Point Safety System



Nitron® Stainless Steel Slide



SAS® (SIG ANTI-SNAG)



Threaded Barrel



Rear Sight Plate



ROMEOT PRO™ Reflex Sight

SIZING UP YOUR SITUATION

You want a pistol with frame dimensions directly suited to your needs. Whether you'll be sliding your handgun into a range bag, concealing it in a purse, shooting competitively, or defending your home, SIG SAUER® offers a pistol for every shooter.



FULL-SIZE

When shootability and sighted accuracy are a must. Generous dimensions and even weight distribution help to deliver a more accurate sight picture and reduced felt recoil.

Barrel > 4" Frame > 7.5 x 5.5"



CARRY

A balance of shootability with concealment. A full-size grip allows the shooter more control while reduced slide length offers lighter carry.

Barrel < 4" Frame 7 x 5.5"



COMPACT

If concealment is an essential requirement, the reduced slide length and grip height enable easy concealment and carry, with ergonomics designed to promote point-and-shoot accuracy.

Barrel < 4" Frame ~ 7 x 5"



MICRO-COMPACT

Discreet, lightweight, and able to fit almost anywhere. Often called "pocket pistols," the SIG micro-compact delivers the ultimate in concealment.

Barrel < 3.5" Frame < 5.8 x 4.3"

TRIGGER TIME

Any expert will tell you, it's the trigger that ultimately puts rounds on target. Weigh the pros and cons of each trigger carefully to select the one you can fire accurately, and carry with confidence.

STRIKER-FIRED TRIGGER

STR | Short Tactile Reset

Every trigger pull has the same weight and feel with a quick tactile reset to ensure faster and more consistent shots.

HAMMER-FIRED TRIGGER

DA/SA | Double-Action/Single-Action

The first trigger pull performs the double-action of cocking the hammer and then releasing the sear. Followed by lighter, single-action trigger pulls on all subsequent shots. The heavier first trigger pull acts to reduce inadvertent discharges.

SAO | Single-Action-Only

The trigger performs the single-action of releasing the hammer with a consistent trigger pull that is generally regarded as the shortest, lightest, and smoothest available. The slide can still be operated with the safety engaged (a SIG exclusive on P220, P226, P229, P238, and P938 models). All models feature a manual thumb safety.

THE CALIBER DEBATE

Popular opinions vary widely, but only you can select the right caliber for you. Consider bullet weight and velocity, your desired magazine capacity, ammunition cost, and availability.



.45AUTO

Known for a combination of power and controlled penetration, due to a large diameter bullet and moderate velocities.



10MM

Offers higher velocity, greater range, and more kinetic energy than the .45AUTO.



.40S&W

Designed to match the performance of the FBI's reduced-velocity 10mm in a smaller cartridge size while offering an energy advantage over the 9mm.



.357SIG

Developed in 1994 to duplicate the performance of a 125 gr .357 Magnum cartridge. The .357SIG combines relatively high velocity with remarkably flat trajectory.



9MM

Regarded as the world's most popular and widely used handgun cartridge combining a flat trajectory with relatively low felt recoil.



.380ACP

Compact and light design make it popular in handguns designed for concealed carry. Less powerful than larger calibers minimizing recoil and improving controllability.



RED DOT REVOLUTION

As the only manufacturer in the industry that can truly integrate a firearm and an optic into a single system that's ready to shoot, right out of the box, SIG SAUER® is leading a Red Dot Revolution that transform the way you shoot. SIG SAUER now offers virtually all of our most popular pistols with the option of a factory-installed, and zeroed, reflex optic. Greater performance, increased accuracy, and radically simple - welcome to the Red Dot Revolution.

WHY PISTOL MOUNTED OPTICS?

Designed for fast, responsive target acquisition and accuracy, open reflex red dot sights, or pistol-mounted optics, are quickly becoming popular among experienced and novice shooters. Red dot sights allow you to quickly and easily acquire your sight picture and make follow-up shots faster. The inherent simplicity of a single aiming point on the same visual plane as the target, makes red dots extremely easy to use, simply put the dot on the target, and press the trigger.



P320-M17 ROMEIO1PRO™

P226® SAO ROMEIO1PRO

P320® X-FIVE® LEGION ROMEIO1PRO

P320 XCOMPACT ROMEIO1PRO

P365XL™ ROMEIOZERO™



AWARD WINNING P365

The P365 has won numerous product awards throughout 2018 - 2019 years including:

- 2019 NRA Golden Bullseye Award - Shooting Illustrated Handgun of the Year, American Rifleman Product of the Year
- 2019 NASGW-POMA Caliber Award - Best New Handgun
- The Firearms Blog - Best Compact Striker-Fired Pistol
- 2018 On-Target Magazine: Editors Choice Awards
- 2018 Guns & Ammo - Handgun of the Year
- 2018 Industry Choice Awards - Handgun of the Year
- 2018 Ballistics Best - Editors Choice Compact Semi-Automatic Pistol
- 2018 NASGW-POMA Caliber Award - Best Overall Product
- Golden Trigger Award - Innovator in Firearms

P365[®]

MICROCOMPACT SIZE WITH FULL-SIZE CAPACITY

The award-winning P365 has redefined the micro-compact pistol category, quickly becoming one of the most coveted firearms in the industry. The P365 features a patented modified double-stack magazine capable of 10+1, 12+1 or 15+1 full-size capacity. It's ergonomic design makes it more shootable than the typical pocket-sized pistols with a clean, crisp trigger pull you expect from a SIG SAUER[®]. The P365XL[™] ROMEOZero[™] is available with the ROMEOZero reflex optic installed and zeroed right out of the box, making it the most capable micro-compact available today.



new XL ROMEOZERO

9mm
365XL-9-BXR3-RXZ

- ▲ Nitron[®] Stainless Steel Slide with ROMEOZero Installed
- ▲ XSERIES Flat Trigger
- ▲ X-RAY3[™] Day/Night Front Sight
- ▲ 3.7" Barrel
- ▲ Includes 12 Round Magazine

new XL

9mm
365XL-9-BXR3 / 365XL-9-BXR3-MS

- ▲ Nitron Stainless Steel Slide Compatible with ROMEOZero
- ▲ XSERIES Flat Trigger
- ▲ X-RAY3[™] Day/Night Sights
- ▲ 3.7" Barrel
- ▲ Includes 12 Round Magazine
- ▲ Available with Manual Safety



new SAS[®]

9mm
365-9-SAS-C

- ▲ Nitron Ported Slide with SAS Treatment
- ▲ Custom Flush-Fit Tritium Sight
- ▲ 3.1" Ported Barrel
- ▲ Includes (1) 10rd Flush Fit Magazine and (1) 10rd Extended Magazine
- ▲ Only 1" Wide



NITRON

9mm
365-9-BXR3 / 365-9-BXR3-MS

- ▲ Nitron Stainless Steel Slide
- ▲ X-RAY3 Day/Night Sights
- ▲ 3.1" Barrel
- ▲ Includes (1) 10rd Flush Fit Magazine and (1) 10rd Extended Magazine
- ▲ Available with Manual Safety



STATE COMPLIANT MODELS AVAILABLE

365XL-9-BXR3-RXZ-10 / 365XL-9-BXR3-10 / 365XL-9-BXR3-MS-10 / 365-9-BXR3-MS-MA



P320[®]

THE WORLD'S MOST INNOVATIVE HANDGUN

The state-of-the-art SIG SAUER[®] P320 has quickly become one of the most sought after firearms on the market today with its unmatched modularity, unprecedented accuracy, and uncompromising reliability. Chosen by all branches of the U.S. military and law enforcement agencies across the country and around the world - the P320 redefines the modern handgun.



FULL-SIZE

9mm
320F-9-B

- ▲ Nitron[®] Stainless Steel Slide
- ▲ Modular Striker-Fired Pistol
- ▲ Contrast Sights
- ▲ 4.7" Barrel
- ▲ 17rd Magazine
- ▲ 1913 Rail
- ▲ Front Cocking Serrations

COMPACT

9MM / 40S&W / 45AUTO / 357SIG
320C-9-B / 320C-(X)-BSS

- ▲ Nitron[®] Stainless Steel Slide
- ▲ Modular Striker-Fired Pistol
- ▲ SIGLITE[®] Night Sights or Contrast Sights
- ▲ 4.7" Barrel
- ▲ Magazines: 9mm (15rd), .40S&W (13rd), .45AUTO (9rd)
- ▲ 1913 Rail
- ▲ Front Cocking Serrations



STATE COMPLIANT MODELS AVAILABLE

320F-9-B-10 / 320C-9-B-10 / 320C-9-BSS-MS-MA



P320® - M17 / M18

THE CHOSEN ONE

The P320-M17 and M18® are the civilian versions of the M17 and M18, which are the official sidearms of all branches of the U.S. military. The P320-M17 and M18 deliver the same unprecedented accuracy, extreme reliability, and unmatched durability that the U.S. military demands from each and every one of their firearms.



P320-M18

9mm
320CA-9-M18-MS

- ▲ Based on the M18 pistol in-use with the U.S. Military
- ▲ Compact Length Coyote-Tan Slide and Carry Length Grip Module
- ▲ Night Sight Rear Plate, Optic-Ready
- ▲ Manual Safety
- ▲ 3.9" Barrel
- ▲ (2) 21rd / (1) 17rd Magazine

P320-M17

9mm
320F-9-M17-MS / 320F-9-M17

- ▲ Based on the M17 pistol in-use with the U.S. Military
- ▲ Full-Size Length Coyote-Tan Slide and Carry Length Grip Module
- ▲ Night Sight Rear Plate, Optic-Ready
- ▲ Manual Safety
- ▲ 4.7" Barrel
- ▲ (2) 21rd / (1) 17rd Magazine
- ▲ Available without Manual Safety



M17®

Based on the M17
firearm selected by
the U.S. Military

M18

Based on the M18
firearm selected by
the U.S. Military

STATE COMPLIANT MODELS AVAILABLE

320F-9-M17-MS-10 / 320F-9-M17-MS-MA / 320CA-9-M18-MS-10

XSERIES



P320[®] XSERIES

THE STANDARD OF PERFORMANCE

XSERIES models include the enhanced XSERIES grip module with extended beavertail, 4-sided beveled magwell, and a deep trigger guard undercut. The flat trigger and optic-ready slide make the P320X stand above the rest.

LEGION SERIES



NEW X5LEGION

9mm
320X5-9-LEGION-R2

- ▲ Lightened Skeletonized Trigger
- ▲ Dawson Removable Rear Sight Assembly Compatible with ROME01PRO™
- ▲ TXG Heavy XSERIES Grip Module
- ▲ 5.0" Bull Barrel with Solid Steel Guide Rod Compatible with 1911 springs
- ▲ 17rd Mags with Henning Group Aluminum Basepads
- ▲ Included Grip Weight and Removable Magwell



XFULL

9mm
320XF-9-BXR3-R2

- ▲ X-RAY3™ Day/Night Sights
- ▲ Night Sight Rear Plate, Assembly Compatible with ROME01 PRO
- ▲ XCARRY Grip Module
- ▲ 4.7" Barrel
- ▲ 17rd Magazine



XVTAC

9mm
320XF-9-VTAC-R2

- ▲ VTAC Day/Night Sights
- ▲ FDE Stainless Slide Compatible with ROME01PRO
- ▲ XCARRY Grip Module
- ▲ 4.7" Barrel
- ▲ 17rd Magazine



XCARRY TACOPS

9mm
320XCA-9-BAXR3-TACOPS-TB

- ▲ X-RAY3 Day/Night Adjustable Sights
- ▲ Rear Plate, Assembly Compatible with ROME01PRO
- ▲ XCARRY Grip Module
- ▲ 4.6" Threaded Barrel
- ▲ 21rd Magazine



XCOMPACT

9mm
320XC-9-BXR3-R2

- ▲ X-RAY3 Day/Night Sights
- ▲ Night Sight Rear Plate, Assembly Compatible with ROME01PRO
- ▲ XCOMPACT Grip Module
- ▲ 3.6" Barrel
- ▲ 15rd Magazine



STATE COMPLIANT MODELS AVAILABLE

320X5-9-LEGION-R2-10 / 320XF-9-BXR3-R2-10 / 320XC-9-BXR3-R2-10



P320® RXP SERIES

RED DOT ACCURACY RIGHT OUT-OF-THE-BOX

The new P320 RXP series is the next generation of pistol and optics solutions from SIG SAUER®. The RXP series combines the latest advancements in reflex optics, with the world's most innovative handgun. Featuring the new ROMEO1PRO™, each of the RXP series pistols delivers a new level of durability and performance. Available on both the standard and XSERIES P320 pistols, the RXP series are zeroed and ready to shoot, right out of the box allowing users to easily achieve a whole new level of accuracy and performance.



new

FULL-SIZE RXP

- 9mm
320F-9-B-RXP
- ▲ ROMEO1PRO Reflex Sight
 - ▲ Suppressor Height Backup Sights
 - ▲ 4.7" Barrel
 - ▲ 17rd Magazine

new

COMPACT RXP

- 9mm
320C-9-B-RXP
- ▲ ROMEO1PRO Reflex Sight
 - ▲ Suppressor Height Backup Sights
 - ▲ 3.9" Barrel
 - ▲ 15rd Magazine



new

XFULL RXP

- 9mm
320XF-9-BXR3-RXP
- ▲ X-RAY3™ Day/Night Suppressor Sights
 - ▲ Nitron® XSERIES Slide with ROMEO1PRO Installed
 - ▲ XCARRY Grip Module
 - ▲ 4.7" Barrel
 - ▲ 17rd Magazine



new

XCOMPACT RXP

- 9mm
320XC-9-BXR3-RXP
- ▲ X-RAY3™ Day/Night Suppressor Sights
 - ▲ Nitron XSERIES Slide with ROMEO1PRO Installed
 - ▲ XCOMPACT Grip Module
 - ▲ 3.6" Barrel
 - ▲ 15rd Magazine



STATE COMPLIANT MODELS AVAILABLE

320XF-9-BXR3-RXP-10 / 320XC-9-BXR3-RXP-10

P320[®]

MODULAR HANDGUN

A clean, crisp, short trigger reset with safe takedown and unprecedented modularity delivering elite performance for all.

CHOOSE A CALIBER:

The P320 is available in a variety of popular calibers.



9MM



.357SIG



.40S&W



.45 AUTO

CHOOSE GRIP FIT:

Interchangeable grip modules provide optimal grip circumference and access to controls without adding a bulky backstrap.

PG. 190



LARGE

MEDIUM

SMALL

OPTIONAL X-CHANGE KITS

The modular pistol has arrived. Removing P320's fire control group unlocks hundreds of combinations.



SERIALIZED, STAINLESS STEEL FRAME

The serialized unit allows the user to change everything from size, to caliber, to grip at will.



CHOOSE STYLE AND A SIZE:

Provides the modularity to switch between multiple sizes, and between the standard and XGRIP.



XFULL

XCARRY

XCOMPACT

FULL-SIZE

CARRY

COMPACT

P320® FEATURES



EXCEPTIONAL TRIGGER

A smooth, crisp trigger pull and short tactile reset deliver heightened accuracy.



3-POINT TAKEDOWN No trigger pull or tools required:

1. Remove magazine
2. Lock slide to the rear
3. Rotate takedown lever

ADDITIONAL SAFETY FEATURES:

- ▲ Striker Safety
- ▲ Disconnect Safety



SP2022[®]

FULL-SIZE POLYMER HAMMER-FIRED

The SP2022 is a full-size polymer pistol, inspired by the SIG classic line. The SP2022 features the same DA/SA trigger found in SIG SAUER[®] Classic Line pistols, with a durable, lightweight and wear-resistant polymer frame with an integrated M1913 accessory rail. The SP2022 pistols have earned an enviable reputation, and proven track record, of reliable performance in the hands of military and law enforcement professionals around the world.



NITRON[®]

9mm / 40 s&w

E2022-(X)-B

- ▲ Nitron Stainless Steel Slide
- ▲ DA/SA Trigger
- ▲ Contrast Sights
- ▲ 3.9" Barrel
- ▲ Magazines: 9mm (15rd), 40 S&W (12rd)
- ▲ Small and Medium Size Grips Available

NITRON

9mm
E2022-(X)B

- ▲ Nitron Stainless Steel Slide
- ▲ DA/SA Trigger
- ▲ Contrast Sights
- ▲ 3.9" Barrel
- ▲ Magazines: 9mm (15rd), 40 S&W (12rd)
- ▲ Small and Medium Size Grips Available



STATE COMPLIANT MODELS AVAILABLE

SP2022-9-B-CA / SP2022-9-B55-CA



P226[®]

CLASSIC FULL-SIZE PISTOL

Designed for ultimate performance, carried by elite forces, and proven to be a premier combat pistol.

LEGION SERIES



LEGION SAO RXP

- 9mm
E26R-9-LEGION-SAO-RXP
- ▲ LEGION Gray Finished Slide and Frame
 - ▲ Master Shop Flat Trigger
 - ▲ X-RAY3™ Day/Night Sights With ROMEDI PRO™ Reflex Sight
 - ▲ 4.4" Barrel
 - ▲ 15rd Magazine
 - ▲ Available in DA/SA

STATE COMPLIANT MODELS AVAILABLE

226R-9-BSS / 226R-9-LEGION / 226R-9-LEGION-RXP / 226R-9-LEGION-SAO / 226R-9-LEGION-SAO-RXP / MK-25-10 / 226R-9-BSS-CA / 226R-9-SCPN-CA / MK-25-CA / 226RM-9-BSS / 226RM-9-LEGION / 226RM-9-LEGION-SAO / MK-25-MA / 226R-9-XTM-BLKGRY-CA

LEGION RXP

- 9mm
E26R-9-LEGION-RXP
- ▲ LEGION Gray Finished Slide and Frame
 - ▲ Master Shop Designed Trigger
 - ▲ X-RAY3 Day/Night Sights With ROMEDI PRO Reflex Sight
 - ▲ 4.4" Barrel
 - ▲ 15rd Magazine



LEGION

- 9mm
E26R-9-LEGION
- ▲ LEGION Gray Finished Slide and Frame
 - ▲ Master Shop Designed Trigger
 - ▲ X-RAY3 Day/Night Sight
 - ▲ 4.4" Barrel
 - ▲ 15rd Magazine



LEGION SAO

- 9mm
E26R-9-LEGION-SAO
- ▲ LEGION Gray Finished Slide and Frame
 - ▲ Master Shop Flat Trigger
 - ▲ X-RAY3 Day/Night Sight
 - ▲ 4.4" Barrel
 - ▲ 15rd Magazine



MK25

- 9mm
MK-25
- ▲ Nitron® Stainless Steel Slide
 - ▲ SIGLITE® Night Sights
 - ▲ 4.4" Barrel
 - ▲ 15rd Magazine
 - ▲ Corrosion-Resistant Internal Coating
 - ▲ Anchor Engraving, UID Label



NITRON[®]

- 9mm
E26R-9-BSS
- ▲ Nitron Stainless Steel Slide
 - ▲ SIGLITE Night Sights
 - ▲ 4.4" Barrel
 - ▲ 15rd Magazine
 - ▲ One-Piece Ergonomic Grip





P229[®]

CLASSIC COMPACT PISTOL

Compact reliability trusted by federal law enforcement professionals for decades.

LEGION SERIES



LEGION SAO

- 9mm
E29R-9-LEGION-SAO / E29R-9-LEGION-SAO-RXP
- ▲ LEGION Gray Finished Slide and Frame
 - ▲ Master Shop Flat Trigger
 - ▲ X-RAY3™ Day/Night Sights
 - ▲ 3.9" Barrel
 - ▲ 15rd Magazine

LEGION RXP

- 9mm
E29R-9-LEGION-RXP
- ▲ LEGION Gray Finished Slide and Frame
 - ▲ Master Shop Designed Trigger
 - ▲ X-RAY3 Day/Night Sights With ROME01PRO Reflex Sight
 - ▲ 3.9" Barrel
 - ▲ 15rd Magazine



LEGION

- 9mm
E29R-9-LEGION
- ▲ LEGION Gray Finished Slide and Frame
 - ▲ Master Shop Designed Trigger
 - ▲ X-RAY3 Day/Night Sights
 - ▲ 3.9" Barrel
 - ▲ 15rd Magazine



NITRON[®]

- 9mm
E29R-9-BSS
- ▲ Nitron[®] Stainless Steel Slide
 - ▲ SIGLITE[®] Night Sights
 - ▲ 3.9" Barrel
 - ▲ 15rd Magazine
 - ▲ One-Piece Ergonomic Grip



M11-A1

- 9mm
M11-A1
- ▲ Nitron Stainless Steel Slide
 - ▲ SIGLITE[®] Night Sights
 - ▲ 3.9" Barrel
 - ▲ Non-Railed Black Hard-Anodized Frame with UID Label
 - ▲ 15rd Magazine
 - ▲ Polymer Grips



STATE COMPLIANT MODELS AVAILABLE

229R-9-BSS / 229R-9-LEGION / 229R-9-LEGION-RXP / 229R-9-LEGION-SAO / 229R-9-LEGION-SAO-RXP / 229R-9-BSS-CA / 229R-9-ESE-CA / 229RM-9-BSS / 229RM-9-LEGION / 229RM-9-LEGION-SAO / M11-A1-10



P220[®]

CLASSIC FULL-SIZE PISTOL

The original SIG SAUER[®] pistol that started it all—a Classic. Available in both .45 AUTO and 10mm.



LEGION SERIES



LEGION SAO

45AUTO
220R-45-LEGION-SAO

- ▲ LEGION Gray Finished Slide and Frame
- ▲ Master Shop Flat Trigger
- ▲ X-RAY3™ Day/Night Sights
- ▲ 4.4" Barrel
- ▲ 8rd Magazine

LEGION

45AUTO
220R-45-LEGION

- ▲ LEGION Gray Finished Slide and Frame
- ▲ Master Shop Designed Trigger
- ▲ X-RAY3 Day/Night Sight
- ▲ 4.4" Barrel
- ▲ 8rd Magazine



LEGION 10MM

10mm
220R5-10-LEGION

- ▲ LEGION Gray Finished Slide and Stainless Steel Frame
- ▲ Master Shop Designed Trigger
- ▲ X-RAY3 Day/Night Sights
- ▲ 5.0" Barrel
- ▲ 8rd Magazine



LEGION 10MM SAO

45AUTO
220R5-10-LEGION-SAO

- ▲ LEGION Gray Finished Slide and Stainless Steel Frame
- ▲ Master Shop Designed Trigger
- ▲ X-RAY3 Day/Night Sights
- ▲ 5.0" Barrel
- ▲ 8rd Magazine



STATE COMPLIANT MODELS AVAILABLE

220RM-45-LEGION / 220R-45-BSS-CA



1911

CLASSIC 45 AUTO PISTOL

The legendary ergonomics and accuracy of the 1911, engineered with modern refinements and SIG reliability.



PART #: Replace (X) with Choice of Caliber



MOLON LABE Engraved Slide

SPARTAN II

45 AUTO
1911R-45-SPARTANII / 1911CAR-45-SPARTANII

- ▲ Distressed Coyote-Tan Stainless Steel Slide and Frame
- ▲ MOLON LABE Engraved Slide
- ▲ Custom Spartan Grips
- ▲ Ambidextrous Safety
- ▲ 5.0" Barrel
- ▲ 8rd Magazine
- ▲ Available in Carry Size

EMPEROR SCORPION

45 AUTO
1911R-45-ESCPN

- ▲ FDE Slide and Frame
- ▲ Front Cocking Serrations
- ▲ 1913 Rail
- ▲ 5.0" Barrel
- ▲ 8rd Magazine



TACOPS

10mm
1911R-10-TACOPS

- ▲ Nitron® Stainless Steel Slide and Frame
- ▲ Custom Grips with SIG Medallion
- ▲ 1913 Rail
- ▲ 5.0" Barrel
- ▲ 8rd Magazine



STX

45 AUTO
1911M-45-STX

- ▲ Nitron Stainless Steel Slide and Natural Stainless Frame
- ▲ Custom Burled Maple Grips
- ▲ Stainless Steel Magwell
- ▲ 5.0" Barrel
- ▲ 8rd Magazine



FASTBACK CARRY EMPEROR SCORPION

45 AUTO
1911FTCA-45-ESCPN

- ▲ Nitron Stainless Steel Slide and Frame
- ▲ Match Grade Barrel
- ▲ Low-Profile Contrast Sights
- ▲ 5.0" Barrel
- ▲ 8rd Magazine



Traditional Contour Slide



STATE COMPLIANT MODELS AVAILABLE

1911R-45-BSS-CA / 1911M-45-STX / 1911RM-45-ESCPN / 1911R-45-SSS-CA



P238[®]

MICRO-COMPACT PISTOLS

Inspired by the 1911, this easy-to-conceal, all metal firearm chambered in .380ACP features exceptional accuracy.



SPARTAN II

.380ACP
238-380-SPARTANII

- ▲ Distressed Coyote Tan Finish Slide and Frame
- ▲ SIGLITE[®] Night Sights
- ▲ 2.7" Barrel
- ▲ 7rd Magazine
- ▲ Custom Spartan Grips and Slide Engraving

NITRON[®]

.380ACP
238-380-B

- ▲ Nitron Stainless Steel Slide
- ▲ Contrast Sights
- ▲ 2.7" Barrel
- ▲ 7rd Magazine
- ▲ Black Polymer Grips



DESERT

.380ACP
238-380-DES

- ▲ Custom Two-Tone Desert Finish
- ▲ SIGLITE Night Sights
- ▲ 2.7" Barrel
- ▲ 7rd Magazine
- ▲ FDE Rubber Grip



RAINBOW

.380ACP
238-380-RBT

- ▲ Rainbow Titanium Slide
- ▲ SIGLITE Night Sights
- ▲ 2.7" Barrel
- ▲ 6rd Magazine
- ▲ Rosewood Grips



STATE COMPLIANT MODELS AVAILABLE

238-380-TSS1-CA / 238-380-HD2-CA / 238M-380-RBT



P938[®]

MICRO-COMPACT PISTOLS

A 1911-inspired 9mm that's easy to conceal and even easier to shoot.

LEGION SERIES



LEGION

9mm
938-9-LEGION

- ▲ LEGION Gray Finished SAS[®] Slide and Frame
- ▲ X-RAY3™ Day/Night Sights
- ▲ 3.0 Barrel
- ▲ 7rd Magazine
- ▲ Flat Trigger and Skeletonized Hammer
- ▲ Extended Magwell

SPARTAN II

9mm
938-9-SPARTANII-AMBI

- ▲ Distressed Coyote Tan Finish Slide and Frame
- ▲ SIGLITE[®] Night Sights
- ▲ 3.0" Barrel
- ▲ 7rd Magazine
- ▲ Custom Spartan Grips and Slide Engraving



BRG

9mm
938-9-BRG-AMBI

- ▲ Nitron[®] Stainless Steel Slide
- ▲ SIGLITE Night Sights
- ▲ 3.0" Barrel
- ▲ 7rd Magazine
- ▲ Black Rubber Grips



NITRON

9mm
938-9-B-AMBI

- ▲ Nitron Stainless Steel Slide
- ▲ Contrast Sights
- ▲ 3.0" Barrel
- ▲ 6rd Magazine
- ▲ Black Polymer Grips



STATE COMPLIANT MODELS AVAILABLE

938M-9-BRG-AMBI / 938M-9-LEGION



P210®

HERITAGE. TRADITION. PERFORMANCE.

Now you can own one of the finest firearms ever made with the new P210 Target from SIG SAUER® - the latest in the historic line of pistols from SIG. Crafted with unprecedented precision, the P210 Target combines the classic lines and heritage of the original, with updated ergonomics, and a target trigger delivering unparalleled accuracy and shooting performance.



TARGET

- 9mm
- 210A-9-TGT
- ▲ Precision Machined Stainless Steel Slide & Frame
- ▲ SAO Target Trigger
- ▲ Adjustable Sights
- ▲ 5.0" Barrel
- ▲ 8rd Magazine
- ▲ Walnut Target Grips

ONE OF THE FINEST HANDGUNS EVER MADE.

PRECISION MADE

- 1 | REVERSE RAILED SLIDE**
The mark of precision
- 2 | UPDATED ERGONOMIC CONTROLS**
Familiar, smooth controls

IMPECCABLE AESTHETICS

- 3 | NITRON® COATED SLIDE**
Improved lubricity and wear
- 4 | TARGET WALNUT GRIP**
Checkered grip includes magwell

ACCURACY

- 5 | SAO TARGET TRIGGER**
Clean, crisp break
- 6 | ADJUSTABLE SIGHTS**
Low profile for low angle of intersection

LEGION SERIES







LEGION SERIES

For thousands of years, one symbol has been a rallying cry for the world's most revered warriors. And for decades, one brand of firearms has served more elite fighting forces than any other.

WELCOME TO THE LEGION BY SIG SAUER® Painstakingly engineered and enhanced for the discerning few with the same warrior spirit that inspired it. We have always given professionals what they need. Now, we are giving them what they want.

LEGION SERIES

UNLEASH THE WARRIOR SPIRIT.

The SIG P220[®], P226[®], P229[®], P320[®], P938[®]; five of the most highly regarded firearms in the professional community are receiving the LEGION Series enhancements based on the needs and wants of elite users. For those who demand the best, we now have something even better — welcome to the LEGION.

LEGION ENHANCEMENTS

- 1 | **LEGION Gray Finish**
Enhances durability & lubricity
- 2 | **Solid Steel Guide Rod**
Reduces muzzle flip
- 3 | **Checkering Under Trigger Guard**
Minimizes lateral movement
- 4 | **X5 Undercut**
Accommodates high grip techniques
- 5 | **Grayguns Inc. Designed Trigger**
Adjustable for over-travel
- 6 | **Reduced Profile Controls**
Prevents premature activation of slide stop with improved texture for better control
- 7 | **Three Magazines**
Delivers more value
- 8 | **Elite Beavertail Reduction**
Reduces printing when concealed
- 9 | **Enhanced Polished Action with SRT**
Smoother DA trigger press that enables faster follow-up shots
- 10 | **Front Cocking Serrations**
For easy slide operation
- 11 | **Custom G10 Grips**
Provides enhanced control for high grip techniques
- 12 | **X-RAY3™ Sights**
Optimizes sight acquisition in all lighting conditions
- 13 | **Enhanced Front Strap Checkering**
Provides a more secure grip for better control
- 14 | **Extended Magwell**
Provides a larger flared opening for faster reloading
- 15 | **Flat Aluminum Trigger**
Increased mechanical advantage for a lighter trigger pull



LEGION SERIES



JOIN THE LEGION.

Become part of the SIG SAUER® LEGION for members-only access to unique opportunities and gear. To join the LEGION purchase and register your LEGION Series™ firearm, and unlock a full range of exclusive benefits.

FREE GEAR LEGION membership entitles you to a complimentary 5.11 premium zippered pistol case for your LEGION firearm, plus a challenge coin matched to your gun.

EXCLUSIVE ACCESS When you call to receive your free case and coin, you will be automatically registered as a LEGION member, providing you exclusive access to gear and merchandise.

EXCLUSIVE COMMUNICATIONS Be the first to know about new additions to the LEGION Series of firearms. You'll also receive other exclusive communications from SIG SAUER and the LEGION.

THIS IS ONLY THE BEGINNING

The initial LEGION Series™ models just scratch the surface of the vast SIG SAUER lineup for the future. Expect to see a broad array of LEGION Series firearms and accessories, along with unique experiences only available to LEGION owners.

LEGION GEAR

LEGION members get exclusive access to LEGION gear and merchandise you can't get anywhere else.

STREAMLIGHT® TLR-1 HL®

- ▲ Wide Beam Pattern
- ▲ Durable, Anodized Aluminum Construction
- ▲ High Temperature, Shock-Mounted, Impact-Resistant Glass Lens
- ▲ Ambidextrous Momentary/Steady On-Off Switch, Double Tap for Strobe (Configurable to Lock Out Strobe)
- ▲ 800 Lumens



BLACKPOINT TACTICAL™ POLYWING OWB HOLSTER

- ▲ Durable Construction
- ▲ Premium Fit and Finish Designed in Collaboration with BlackPoint and SIG SAUER
- ▲ Flexible Poly Wing for the Comfort of Soft Holsters and the Security of Thermal Molded Holsters
- ▲ Adjustable Retention



MITCH ROSEN® EXTRAORDINARY GUNLEATHER HOLSTER

- ▲ Comfortable for every day, all day use
- ▲ Premium Fit and Finish Designed in Collaboration with Mitch Rosen and SIG SAUER
- ▲ Designed for OWB Concealment



LEGION FLEECE JACKET

- ▲ Custom Designed for LEGION Members, Subtly Branded
- ▲ Fabric 100% Polyester
- ▲ Water and Wind Resistant
- ▲ Open Bottom Hems
- ▲ Relaxed Fit



RANDOLPH® AVIATORS

- ▲ Hand Crafted Custom for SIG SAUER LEGION Members
- ▲ Polarized 100% UVA/UVB Protection
- ▲ Anti-Reflective Coating
- ▲ Randolph USA's Signature Neutral Gray Tint Lenses
- ▲ Frames are Guaranteed for Life



SUREFIRE® E1B BACKUP LIGHT

- ▲ Compact Dual-Output Flashlight with a 200-Lumen Maximum Output
- ▲ Ideal for Everyday-Carry, Self-Defense, or Outdoor Applications
- ▲ Indestructible LED Emitter and a Precision Total Internal Reflection (TIR) Lens
- ▲ Lightweight Mil-Spec Hard-Anodized Aluminum Body



PELTOR™ COMTAC™ III HEARING DEFENDER

- ▲ Redesigned Cup Profiles to Better Accommodate ACH and MICH Helmet Compatibility
- ▲ 500 Hour Battery Life, (Common AAA Battery Power)
- ▲ Comfort Gel Cups
- ▲ Highest Rated (Passive) Hearing Protection Available
- ▲ External Microphones for "Talk-Thru" Capability

CUSTOM WORKS

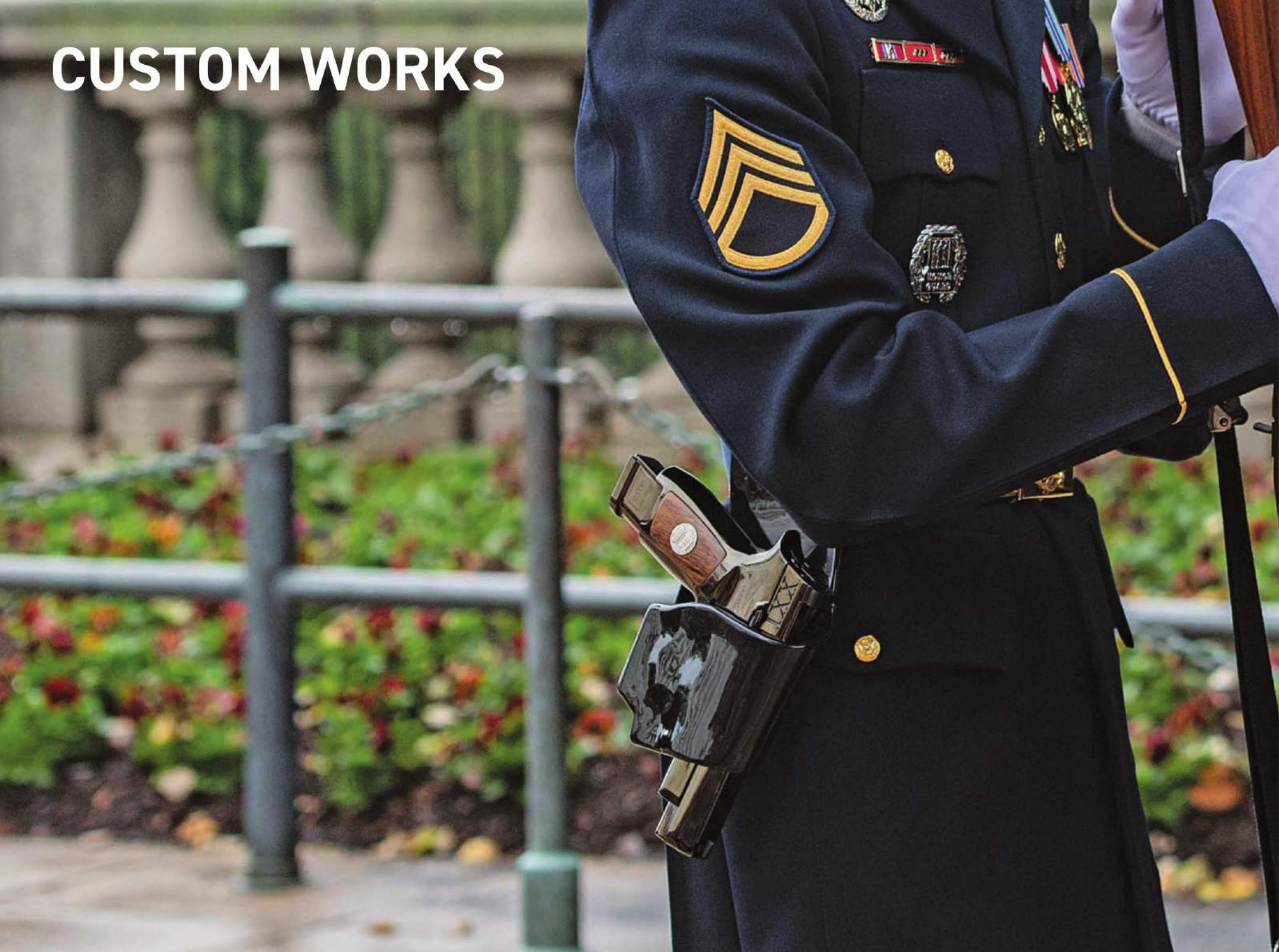



CUSTOM WORKS

ONE MILLIONTH P320®

The SIG SAUER P320 is fast becoming one of the most iconic and historic guns in history, and because of its immense popularity it has been tested, proven, and chosen at unprecedented rates by consumers and professionals alike. As the only truly modular handgun in the world, it was born from hard work, drive, dedication, and was subsequently adopted by all branches of the U.S. Military as the M17 and M18, and is now in service with law enforcement, military and special forces around the world. The P320 has also taken over the world of competition, as some of the greatest professional shooters in the sport have won championships and set world records using P320s.

In 2019, the SIG SAUER P320 reached a historic milestone when serial number 58H1000000 was born and thus the one millionth P320. To celebrate the innovation that is the SIG SAUER P320, the standard bearer of the modern-day pistol, SIG SAUER Custom Works has created a one-of-a-kind milestone P320.

The SIG SAUER P320

Tested to ensure extreme reliability and durability.

Proven to deliver unprecedented accuracy.

Chosen by the all branches of the US military and the world's most demanding users.



Hand-cut granite grips to commemorate New Hampshire, the Granite State as the birthplace of the P320 pistol, and printed with the "SIG" mark logo.



Marked "58H1000000" for the 1,000,000th P320 Pistol



ONE MILLIONTH P320

FEATURES

- Frame: An all-metal frame with a high-gloss polished finish
- Slide Engraving: Scroll engraving with 14k gold inlay, and "1,000,000th P320"
- The 1,000,000th P320 is a 9mm pistol with standard P320 features including XRAY-3 day/night sights and an optic cut.

SIG CUSTOM WORKS

The mission of SIG Custom Works is to deliver personalized design, elite performance, and uncompromising craftsmanship.

EXPERIENCE: From the fit and finish, to the way each product is packaged and delivered, SIG Custom Works creates a truly special experience for our customers.

INNOVATION: Take your firearm to the next level with state-of-the-art designs, new processes, and performance enhancements by SIG Custom Works.

QUALITY: Every SIG Custom Works pistols is built to exacting standards by the SIG SAUER® craftsmen who are driven by their uncompromising standards for excellence.

RELATIONSHIPS: Receive a personalized experience at SIG Custom Works that results in a firearm to fit your personal style and specifications.

For more information on SIG Custom Works services visit sigsauer.com



RIFLES





ARE

DECKED

MONTANA - 10



MCX VIRTUS[®]

THE CHOICE OF THE WORLD'S ELITE

In use by more special operations forces around the world than any other AR the SIG MCX VIRTUS is engineered for adaptability, sound suppression, and extreme longevity. Featuring user-changeable, cold hammer-forged barrels available in both 5.56 NATO and 300 BLK, with the SIG internal recoil system offering reduced recoil, and a folding stock that makes it the ultimate compact rifle platform.



PISTOL 11.5" / 9"

5.56 NATO / 300 BLK
PMCX-11B-TAP / PMCX-300B-9B-TAP

- ▲ SIG MATCHLITE Duo Trigger
- ▲ Interchangeable Cold Hammer-Forged Barrels
- ▲ M-LOK[®] Free-Float Handguard with Expanded Valve Windows
- ▲ Ambidextrous Selector, Mag Release, and Charging Handle
- ▲ Adjustable Gas Valve
- ▲ Folding, Fixed PCB Brace



PATROL 16"

5.56 NATO
RMCX-16B-TAP-P

- ▲ SIG MATCHLITE[™] Duo Trigger
- ▲ Interchangeable Cold Hammer-Forged Barrels
- ▲ M-LOK[®] Free Float Handguard with Expanded Valve Windows
- ▲ Ambidextrous Selector, Mag Release, and Charging Handle
- ▲ Adjustable Gas Valve
- ▲ 5-Position Tele-Folding Stock



2018 BALLISTIC'S BEST
Semi-Automatic Rifle, Reader's Choice

STATE COMPLIANT MODELS AVAILABLE

PMCX-11B-TAP-CO



MCX VIRTUS® - NEXT LEVEL MODULARITY AND PERFORMANCE





MCX RATTLER

THE WORLDS MOST COMPACT RIFLE

Developed for elite special forces, the SIG MCX Rattler is the most compact rifle in the world. Capable of firing with stock folded from an overall length of 16", it redefines the standard for concealable firepower.



SBR 5.5"

5.56 NATO / 300 BLK
RMCX-300B-5B-TAP-SBR / RMCX-5B-TAP-SBR

- ▲ SIG MATCHLITE Duo Trigger
- ▲ Fixed Folding Mini Stock
- ▲ M-LOK Handguard



PCB 5.5"

5.56 NATO / 300 BLK
PMCX-5B-TAP / PMCX-300B-5B-TAP

- ▲ SIG MATCHLITE Duo Trigger
- ▲ Folding Fixed PCB Brace
- ▲ M-LOK Handguard



CANEBRAKE 5.5"

300BLK
PMCX-300B-5B-TAP-CANE

- ▲ SIG MATCHLITE™ Duo Coyote Tan Flat-Blade Trigger
- ▲ Folding Fixed PCB Brace
- ▲ PDW M-LOK® SD Handguard
- ▲ 7.62 Inert Trainer



2018 Industry Choice Awards
Rifle Caliber Pistol of the Year



MPX

GAS PISTON SUB-GUN

The MPX sets a new standard for performance and quality in the sub-gun category. Featuring AR style controls and a closed-bolt piston system, the MPX is designed to fulfill the needs of competitive, professional, and civilian users.



PCC 16"

9MM
RMPX-16B-9

- ▲ Timney Single-Stage Trigger
- ▲ 16" Threaded Barrel
- ▲ Narrow M-LOK® Free-Floating Handguard
- ▲ 5-Position Tele-Folding Stock
- ▲ 3-Chamber Compensator



COPPERHEAD

9mm
PMPX-3B-CH

- ▲ Rapid Deploy PCB Brace
- ▲ 3.5" Barrel with Integrated Brake
- ▲ Monolithic Upper
- ▲ Coyote Tan E190 Cerakote® Finish



COPPERHEAD K

9mm
PMPX-4B-CH

- ▲ Timney Single-Stage Trigger
- ▲ Rapid Deploy PCB Brace
- ▲ 4.5" Threaded Barrel
- ▲ Monolithic Upper



MPX K

9mm
PMPX-4B-9

- ▲ Timney Single-Stage Trigger
- ▲ Folding Fixed PCB Brace
- ▲ Free-Floating M-LOK Handguard

STATE COMPLIANT MODELS AVAILABLE

PMPX-3B-CH-CO



716

LIGHTWEIGHT BIG BORE AR PLATFORM

With a lightweight design and MOA accuracy, the 716 has become one of the best known big bore AR's on the market today. Featuring an ambidextrous lower receiver, a precision carbon steel barrel, and a free floating M-LOK® handguard, the 716 provides a versatile platform for long range shooting and hunting while maintaining a lightweight design for easy carry. Now available as part of the TREAD® rifle platform, the TREAD 716 is easily customizable with a full line of TREAD accessories.



716G2 DMR 18"

6.5 CREEDMOOR
R716G2-H18B-65-DMR-FDE

- ▲ 2-Stage MATCHLITE™ Duo Trigger
- ▲ Magpul PRS® Gen3 Stock
- ▲ 18" Precision Barrel
- ▲ Free-Floating M-LOK® Handguard
- ▲ 3-Chamber Compensator
- ▲ Gas Piston System



new

TREAD 16"

7.62x51 NATO
R716I-16B-TRD

- ▲ Adjustable Magpul® SLK Stock
- ▲ Free-Floating M-LOK® Handguard
- ▲ 16" Precision Barrel
- ▲ Ambidextrous Controls
- ▲ Direct Impingement

THE NEW FACE OF FREEDOM

TREAD



M400 TREAD®

THE NEW FACE OF FREEDOM

Introducing the new M400 TREAD from SIG SAUER®; all the features, all the freedom - none of the compromises. The TREAD is engineered to deliver exceptional quality and performance, and comes standard with the most sought-after features for today's AR platform rifles. Unlike most rifles in its class, the TREAD is easily customizable with a full line of purpose-built accessories. The TREAD from SIG SAUER - the new face of freedom.

THE NEW FACE OF FREEDOM



NEW

TREAD PISTOL 11"

5.56 NATO
PM400-11B-TRD

- ▲ Polished and Hardened Single-Stage Trigger
- ▲ Adjustable Shockwave® Brace
- ▲ Free-Floating M-LOK® Handguard
- ▲ 11.5" Stainless Barrel
- ▲ Ambidextrous Controls
- ▲ Microlite Gas Block



TREAD COIL

5.56 NATO
RM400-16B-TRD-COIL

- ▲ The Most Popular TREAD Accessories Factory Installed
- ▲ MATCHLITE™ Duo Trigger
- ▲ 13" Lightweight M-LOK® Handguard
- ▲ Tread ROME05™ Red Dot
- ▲ Vertical Foregrip



TREAD 16"

5.56 NATO
RM400-16B-TRD

- ▲ Polished and Hardened Single-Stage Trigger
- ▲ Magpul® SL-K™ Stock
- ▲ Free-Floating M-LOK® Handguard
- ▲ 16" Stainless Barrel
- ▲ Ambidextrous Controls
- ▲ Microlite Gas Block with Mid-Length Gas System

M400 TREAD®

THE COMPLETE TREAD SYSTEM

PURPOSE-BUILT, CUSTOM ACCESSORIES THAT GIVE YOU THE FREEDOM TO GROW AND CUSTOMIZE

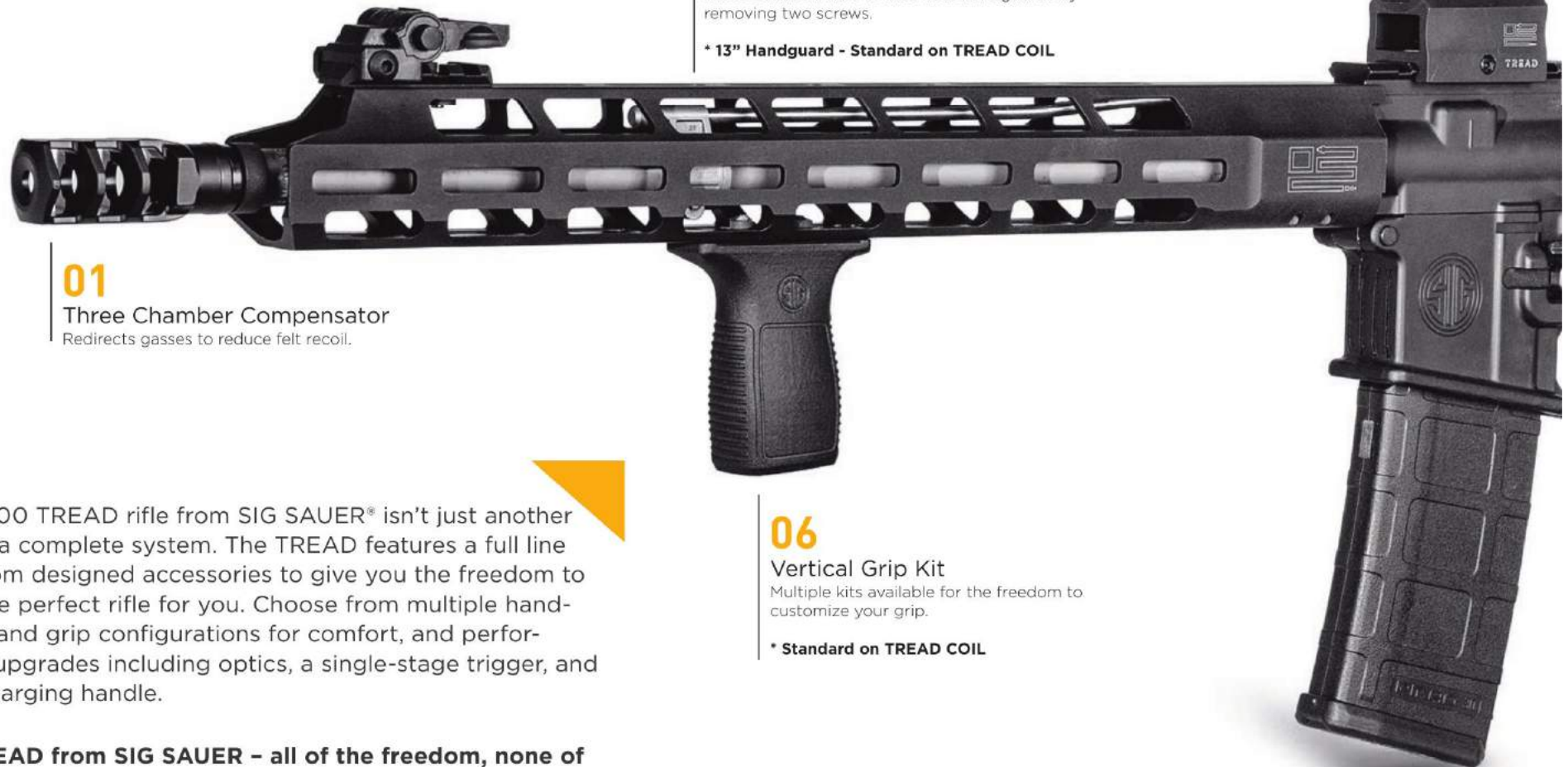

01

Three Chamber Compensator
Redirects gasses to reduce felt recoil.

02

15" Lightweight M-LOK® Handguard
Compatible with all M-LOK rail systems. Quickly move between TREAD free-float handguards by removing two screws.

* 13" Handguard - Standard on TREAD COIL

06

Vertical Grip Kit
Multiple kits available for the freedom to customize your grip.

* Standard on TREAD COIL

03

TREAD ROMEO5 Optic
2MOA dot with 10 illumination settings, MOTAC, and a 50k hour battery life.

* Standard on TREAD COIL

The M400 TREAD rifle from SIG SAUER® isn't just another AR, it's a complete system. The TREAD features a full line of custom designed accessories to give you the freedom to build the perfect rifle for you. Choose from multiple handguards and grip configurations for comfort, and performance upgrades including optics, a single-stage trigger, and ambi charging handle.

The TREAD from SIG SAUER - all of the freedom, none of the compromises.

04

Flip-Up, Back-Up Locking Iron Sights

Compatible with picatinny rail systems, Tool-less windage and elevation adjustment. Button-less flip up and locks in position.

05

Ambi Charging Handle

Optimized for right or left-hand operation. Solid construction for prolonged use, and built for maintenance free reliability.



07

Flat Blade Two-Stage Trigger

Vertical trigger profile for a precise feel, and crisp break for maximum performance.

* Standard on TREAD® COIL

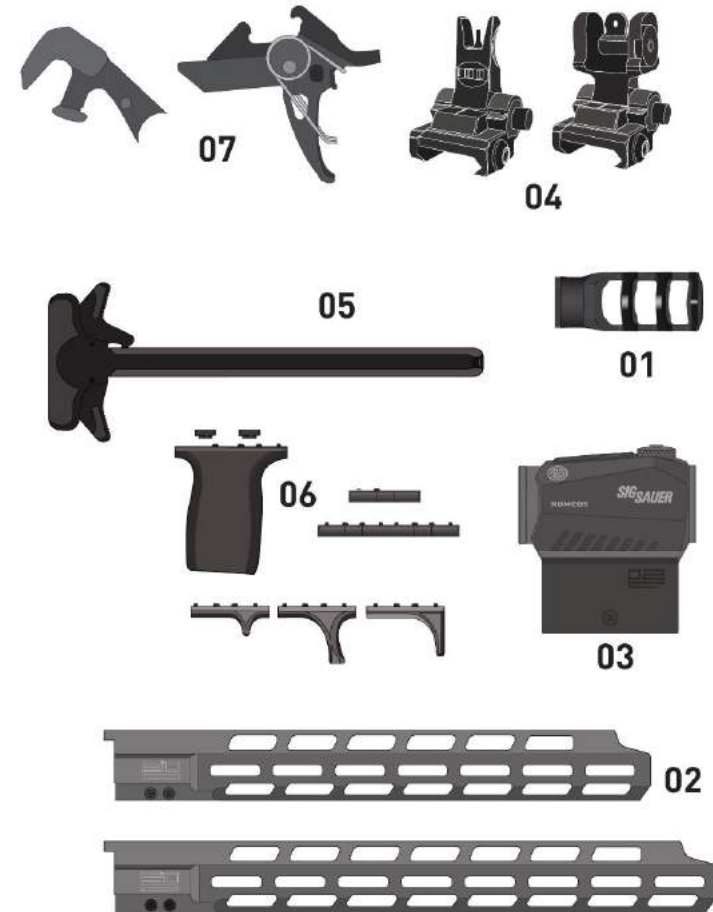

For a complete list of TREAD series accessories offered by SIG SAUER, please visit sigsauer.com/TREAD.





Shot on location in the San Juan and Rio Grande National Forests. Permission granted under special use authorization.

CROSS RIFLE

PRECISION HUNTING BOLT-ACTION RIFLE

Developed by hunters and elite long-range shooters, the CROSS rifle was created to meet the demands of both PRS shooting and backcountry hunting.

- Under 6.5 lbs, the lightest, most portable rifle in its class (up to 40% lighter)
- Folding precision-style stock
- 1-piece receiver for increased accuracy
- Available in .308 / 277 SIG FURY with a 16" barrel (collapsible to 25")
- Available in 6.5 Creedmoor with a 18" barrel (collapsible to 27")
- Designed and built in the U.S.A.



NEW

CROSS RIFLE CAMO

.308 WIN / 6.5 CREEDMOOR / 277 SIG FURY
CROSS-308-16B-FLC / CROSS-65-18B-FLC /
CROSS-277-16B-FLC

- ▲ 2 Stage Match Trigger
- ▲ Fully Adjustable and foldable SIG Precision Stock
- ▲ Free Floating M-LOK® Handguard
- ▲ One Piece Aluminum Receiver
- ▲ SIG Match Grade Stainless Barrel
- ▲ Removable Top Mounted Pic Rail
- ▲ Threaded Tapered Muzzle
- ▲ First Lite Cipher Armorkote® Finish



NEW

CROSS RIFLE

.308 / 6.5 CREEDMOOR / 277 SIG FURY
CROSS-308-16B / CROSS-65-18B / CROSS-277-16B

- ▲ 2 Stage Match Trigger
- ▲ Fully Adjustable and foldable SIG Precision Stock
- ▲ Free Floating M-LOK® Handguard
- ▲ One Piece Aluminum Receiver
- ▲ SIG Match Grade Stainless Barrel
- ▲ Removable Top Mounted Pic Rail
- ▲ Threaded Tapered Muzzle
- ▲ Black Anodized



Folding Precision-Style Stock,
Collapsible to 25" overall

AMMUNITION





9MM NATO
124gr +P V-CROWN
JACKETED HOLLOW POINT
SIG SAUER
MILITARY GRADE
E9MMB2P-M17-50
PROUDLY MADE BY SIG IN THE U.S.A.

9MM NATO
124gr +P FMJ
FULL METAL JACKET
MILITARY GRADE
E9MMB2P-M17-50
PROUDLY MADE BY SIG IN THE U.S.A.
SIG SAUER

365
FMJ / OPTIMIZED FOR CCW
50 CENTERFIRE PISTOL CARTRIDGES
SIG SAUER ELITE PERFORMANCE AMMUNITION
9MM LUGER / 115 GRAIN
PROUDLY MADE BY SIG IN THE U.S.A.

ELITE PERFORMANCE AMMUNITION
SIG FMJ
50 Full Metal Jacket
Centerfire Pistol Cartridges
SIG SAUER

365
V-CROWN
FMJ / OPTIMIZED FOR CCW
50 CENTERFIRE PISTOL CARTRIDGES
SIG SAUER ELITE PERFORMANCE AMMUNITION
9MM LUGER / 115 GRAIN
PROUDLY MADE BY SIG IN THE U.S.A.

50 JHP Centerfire Pistol Cartridges
MATCH ELITE
SIG SAUER

ELITE PERFORMANCE AMMUNITION
SIG V-CROWN
20 Jacketed Hollow Point
Centerfire Pistol Cartridges
SIG SAUER

9mm LUGER 115 gr.
V-CROWN
SIG SAUER

357 SIG 125 gr.
V-CROWN
SIG SAUER

45 AUTO 230 gr.
V-CROWN
SIG SAUER



REVOLUTIONARY HYBRID CASE AMMUNITION

Developed for the U.S. Military's Next Generation Weapons System the new SIG FURY™ hybrid case ammunition outperforms standard ammunition in similar calibers, with decreased bullet drop and increased energy on target.

SIG FURY hybrid case ammunition. The next generation of ammunition is here.

Shot on location in the San Juan and Rio Grande National Forests, permission granted under special use authorization.

SIG FURY™

HYBRID CASE AMMO

The biggest innovation in ammunition technology in more than 50 years. The SIG FURY hybrid case technology defies all ballistic theory by producing more energy on target in a smaller, lighter package.

ELITE MATCH GRADE

H277SFM1-20

- ▲ FURY Hybrid Case Technology Delivers Increased Speed for Greater Accuracy at Extended Range
- ▲ Match Grade Projectile Designed to be Flatter Shooting with Less Wind Drift
- ▲ Proprietary Powder Blend to Operate at Maximum Performance Levels
- ▲ Hybrid Case Reduces Failure Points of Traditional Brass Cased Ammunition

ELITE HUNTER TIPPED

H277SFT1-20

- ▲ FURY Hybrid Case Technology Delivers Increased Speed for Greater On-Target Performance
- ▲ Utilizes the Sierra® Tipped GameKing Designed to SIG SAUER Specification
- ▲ Designed for Greater Energy Transfer in Shorter Barrel Lengths
- ▲ Loaded to Exact Standards for Consistency and Reliability from Lot to Lot



ELITE MATCH GRADE
135 grain



ELITE HUNTER TIPPED
140 grain

277 SIG FURY VS 6.5 CREEDMOOR

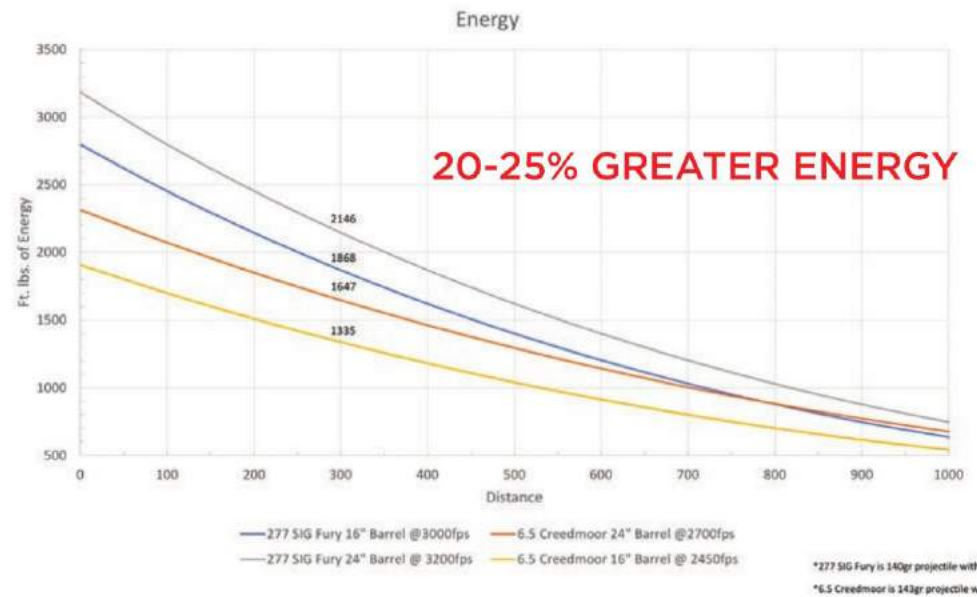
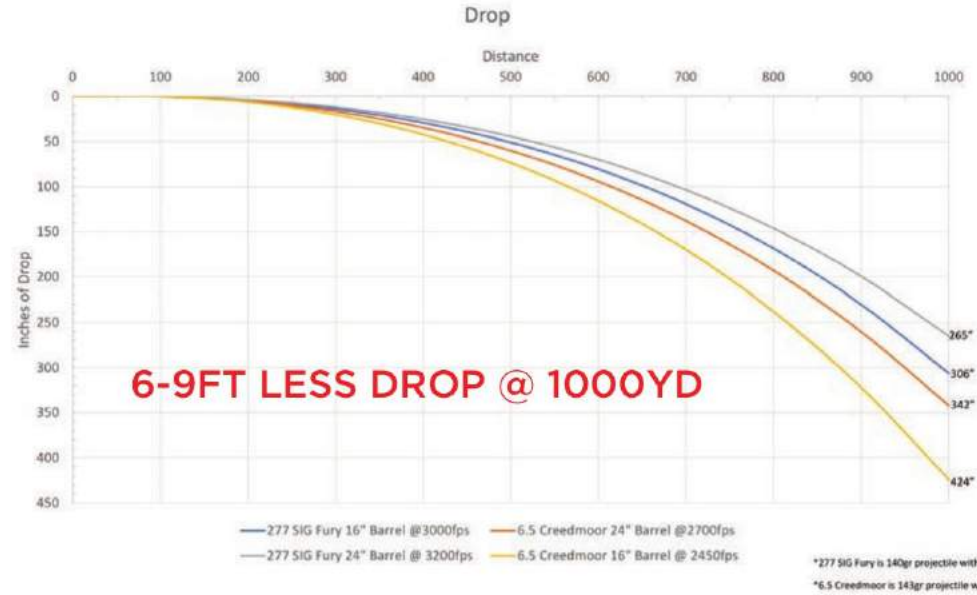

AMMUNITION



ELITE CARRY

JACKETED HOLLOW POINT PISTOL CARTRIDGES

SIG V-CROWN® defensive rounds combine perfected material specifications and fine-tuned design innovations. Featuring a stacked hollow point cavity, to deliver exceptional on-target energy, with maximum weight retention and optimal expansion for the ultimate in stopping power.



FEATURES

1. V-Shaped Jacket with Skives and Scores to Provide Controlled, Uniform Expansion
2. Patented Stacked Hollow Point Bullet Design with Additional Hollow Point Cavity
3. Unique Toothed Cannelure Ensures Maximum Weight Retention and Terminal Expansion
4. Coated Nickel Cases Provide Enhanced Lubricity, Superior Corrosion Resistance, and Reliable Feeding and Extraction
5. Low Flash Propellant
6. Consistent Primers



SIG V-CROWN

E10MM1-20 / E357M1-20 / E357S1-20 / E380A1-20 / E38SP1-20 / E38SU1-20 / E340SW1-20 / E40SW2-20 / E44MA1-20 / E44SP1-20 / E45AP0-20 / E45AP1-20 / E45AP2-20 / E45LC1-20 / E9MMA1-20 / E9MMA2-20 / E9MMA3-20



SIG V-CROWN 365

9MM
E9MMA1-365-20

- ▲ Designed for Optimal use in Short Barrel, Concealed Carry Pistols
- ▲ Low-Flash, Clean-Burning Powders
- ▲ Maximum Terminal Velocity and Penetration
- ▲ Lower Recoil
- ▲ Manufactured to SAAMI Standards
- ▲ Made in the U.S.A.



SIG V-CROWN M17

9MM
E9MMA2P-M17-20

- ▲ Military Grade +P Ammunition
- ▲ Stacked Hollow Point Cavity
- ▲ Maximum Weight Retention and Expansion
- ▲ Ultimate Stopping Power
- ▲ Made in the U.S.A.



*SIG SAUER V-CROWN is optimized for maximum terminal ballistic performance when used in short-barreled firearms.



SIGSAUER
SPEC1
 premium blend
 firearm lubricant
 cleans / lubricates / protects
 2 Fluid Ounces
 NON-TOXIC / NON-PETROLEUM
 PROUDLY MADE
 IN THE U.S.A.

SIGSAUER when it counts
ELITE PERFORMANCE AMMUNITION
 SIG FMJ Centerfire Pistol Cartridges
50 FMJ Centerfire Pistol Cartridges
9MM LUGER | 115 gr. FMJ
 MEI 1183 ft/sec
 359 ft-lbs
 SIGSAUER when it counts
 Made in the USA
 WARNING: KEEP OUT OF REACH OF CHILDREN
 MADE IN THE USA

SIGSAUER when it counts
ELITE PERFORMANCE AMMUNITION
 SIG FMJ
 50 FMJ Meade Jacket
 Centerfire Pistol Cartridges
SIGSAUER when it counts

SIGSAUER when it counts
 Made in the USA

ELITE TRAINING

TRAIN LIKE YOU CARRY

Full Metal Jacket Cartridges Engineered to match SIG V-CROWN® ballistics for a more seamless transition from training to carry ammunition. SIG FMJ delivers the same felt recoil, same barrel rise, and same point of impact as the SIG V-CROWN.

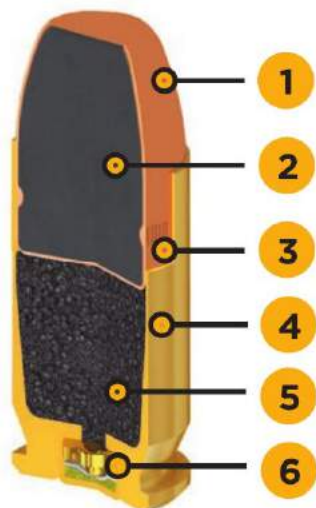

FEATURES

1. Full Metal Jacket Projectile Ballistically Matched to Ensure the Same Point-of-Impact as Elite Carry Ammo
2. Lead Core
3. Bullet Weight and Load Spec's Matched to Elite Carry to Ensure Consistent Felt Recoil and Barrel Rise
4. Brass Cartridge Cases
5. Clean Burning Powders
6. Consistent Primers



SIG FMJ 365

9MM
E9MMB1-365-50



SIG FMJ RIFLE CARTRIDGES

223 REM / 300 BLK / 308 WIN
E223B1-20 / E300B1-20 / E308B1-20



SIG FMJ M17

9MM
E9MMB2P-M17-50



SIG FMJ

E10MB1-50 / E357B1-50 / E357MB-50 / E380B1-50 / E38SB1-50 / E38SUB-50 / E40SB2-50 / E45BA3-50 / E9MMB1-50 / E38SB2-50 / E9MMB3-50 / E9MMLFS1-50



*OPTIMIZED FOR MAXIMUM PERFORMANCE WHEN USED IN SHORT-BARRELED FIREARMS.



ELITE MATCH

PRECISION MATCH GRADE RIFLE CARTRIDGES

SIG Match Grade rifle rounds are engineered to excel in today's precision auto-loading platforms, as well as bolt-action rifles. Utilizing optimized shell case metallurgy and premium primers, each round is precision-loaded using state-of-the-art, electromechanical monitoring for geometric conformity, and all are 100% inspected.

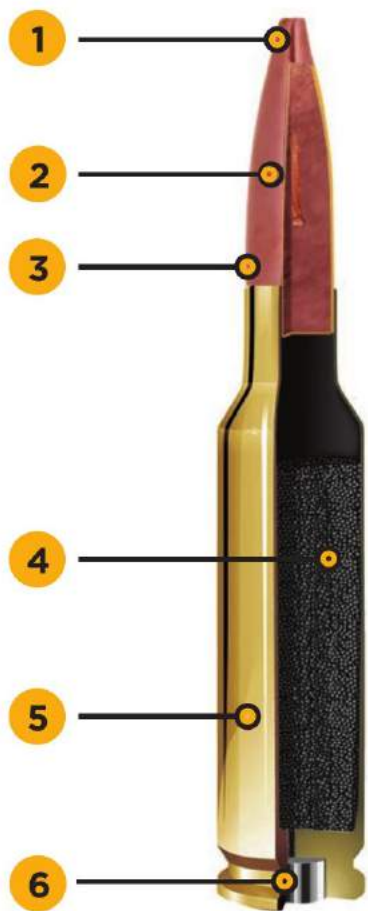

FEATURES

1. Hollow Point Designed to Maximize BC
2. Thin Jacket Design for Precise Concentricity
3. Bullet Weights are Held within +/- 0.3 Grains
4. Temperature-Stable Propellants
5. Brass Cases are 100% Inspected and Lot Controlled
6. Industry Leading Primers are Unmatched in Power and Performance



SIG ELITE MATCH

E223M1-20 / E300A1-20 / E300A2-20 / E308M1-20 / E308M2-20 / E3WMM1-20 / E65CM1-20 / E260M2-20 / E3006M2-20 / E6MMCM2-20

- ▲ Minimal Velocity Variation
- ▲ Precision Loaded for Conformity
- ▲ Renowned Sierra® Matching® Projectile
- ▲ Temperature-Stable Propellants



MATCH ELITE

COMPETITIVE PISTOL CARTRIDGES

SIG Match Elite Competition loads have been designed in conjunction with Team SIG, for the serious competitive shooter who needs an accurate and completely reliable competitive round. Currently offered in a 9mm, 147 grain w³ projectile and loaded in a premium nickel case for improved function and feeding. The round utilizes a reduced charge weight with a fast burning powder, so felt recoil has been reduced significantly for improved accuracy, better gun control, and higher scores.



AMMUNITION



SIG MATCH ELITE 115GR

JHP 9MM
E9MMA1-COMP-50

- ▲ Same Great Features of Existing 9mm V-CROWN
- ▲ Designed Around Steel Challenge Competition
- ▲ Lower Felt Recoil
- ▲ Faster Target Acquisition
- ▲ Increased Accuracy
- ▲ Used by Team SIG Pro Shooters

SIG MATCH ELITE 147GR

JHP 9MM
E9MMA3-COMP-50

- ▲ Same Great Features of Existing 9mm V-CROWN
- ▲ Extremely Precise Power Factor Between 126 and 132*
- ▲ Lower Felt Recoil
- ▲ Faster Target Acquisition
- ▲ Increased Accuracy
- ▲ Used by Team SIG Pro Shooters



FEATURES

1. V-Shaped Jacket with Skives and Scores to Provide Controlled, Uniform Expansion
2. Stacked Hollow Point Bullet Design with Additional Hollow Point Cavity
3. Unique Toothed Cannellure Ensures Maximum Weight Retention and Terminal Expansion
4. Coated Nickel Cases Provide Enhanced Lubricity, Superior Corrosion Resistance, and Reliable Feeding and Extraction
5. Low Flash Propellant
6. Consistent Primers



*When measured from Max. Michel's target pistol



LEAD WARNING: Discharging firearms in poorly ventilated areas, cleaning firearms, or handling ammunition may result in exposure to lead and other substances known to cause birth defects, reproductive harm, cancer and other serious physical injury. Have adequate ventilation at all times. Wash hands thoroughly after exposure. Use only in modern, properly maintained firearms in good condition. Use only in modern, properly maintained firearms in good condition. Check the barrel in condition marked and chambered for use of this cartridge. If the barrel is free of any obstructions, check the barrel during firing. If you usually load or weak sound heard during firing, do not fire. If you usually fire, do not fire. If you usually fire, do not fire.

ELITE HUNTER

TIPPED LEAD CORE HUNTING CARTRIDGES

SIG SAUER® ELITE HUNTER TIPPED ammunition gives the serious sportsman unmatched, long-range accuracy, with devastating on-target performance. Massive expansion delivers instant knockdown and terminal energy on small to medium game.

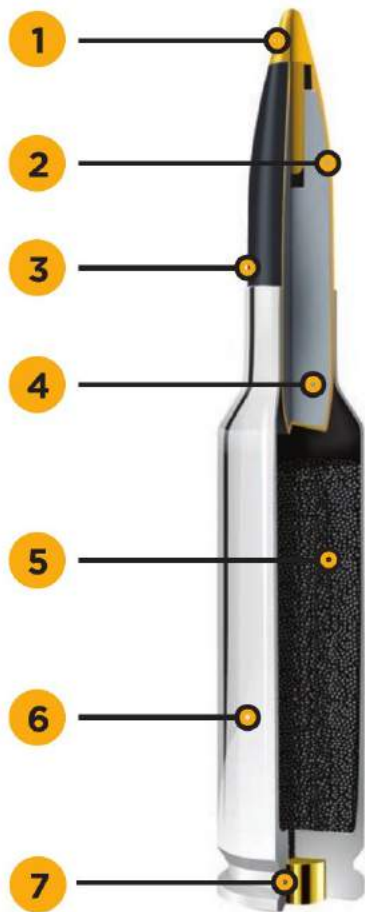

FEATURES

1. Translucent yellow tip increases ballistic coefficient, improves terminal performance, and aids in consistent reliable chambering
2. Exclusive jacket design delivers devastating on-game performance for small to medium game at extended ranges
3. Concentric blackened jacket ensures reliable expansion
4. Enhanced boat tail design provides superior flight characteristics over a wide range of velocities
5. Custom formulated and precision loaded powders deliver consistent velocities regardless of atmospheric conditions
6. Nickel plated cases aid in extraction while providing significant anti-corrosion qualities
7. Industry leading primers are matched to proprietary powder blends to ensure dependable ignition



ELITE HUNTER TIPPED

E243TH2-20 / E260TH1-20 / E270TH2-20 /
E3006TH2-20 / E308TH2-20 / E3WMTH3-20 /
E65CMTH1-20 / E6MMCTH2-20 / E7RMTH2-20



Shot on location in the San Juan and Rio Grande National Forests, permission granted under special use authorization

ELITE HUNTING

COPPER GAME HUNTING CARTRIDGES

SIG ELITE COPPER HUNTING rounds use premium-quality powders and primers for minimum velocity variation, and yield a 1.8x diameter expansion. Perfected for easy rifle feeding, with an optimized nose geometry, and premium nickel-plated shell casings that deliver consistently reliable accuracy for taking down game.



AMMUNITION



FEATURES

1. Optimized Nose Geometry for Easy Rifle Feeding
2. Consistent 1.8X Diameter Expansion
3. Lead-Free Monolithic Copper Bullet
4. Proprietary Powder Blends to Ensure Dependable Ignition
5. Industry Leading Primers are Matched to Proprietary Powder Blends to Ensure Dependable Ignition

*California Fish and Game Code Section 3004.5 Compliant

SIG COPPER HUNTING

E223H1-20 / E308H1-20 / E300H1-20 / E65CH1-20 /
E3WMH1-20 / E6MMCH1-20 / E260H1-20 / E270H1-20 /
E243H1-20 / E3006H1-20





Shot on location in the San Juan and Rio Grande National Forests, permission granted under special use authorization.

ELITE HUNTING

TIPPED VARMINT & PREDATOR RIFLE CARTRIDGES

SIG Tipped Varmint & Predator rounds utilize yellow tipped projectiles designed specifically for explosive expansion and unmatched accuracy. All loads feature projectiles yielding higher muzzle velocities and flatter trajectories across all practical hunting distances.



The Tipped Varmint & Predator rounds contain the same high-quality single-base extruded powders as SIG Match Grade rounds. This ensures consistent round-to-round muzzle velocities and renders it insensitive to temperature change. All SIG Varmint & Predator rounds are produced on state-of-the-art loading equipment utilizing laser technology for charge-weight consistency and geometric conformity.

FEATURES

1. Yellow Tip Increases Ballistic Coefficient, Improves Terminal Performance, and Aids in Consistent Reliable Chambering
2. Jacketed Lead-Core Bullet Designed for Explosive Fragmentation and Quick Take-Down on Varmits
3. Custom Formulated and Precision Loaded Powders Deliver Consistent Velocities Regardless of Atmospheric Conditions
4. Brass Cases Aid in Extraction while Providing Significant Anti-Corrosion Qualities
5. Industry Leading Primers are Matched to Proprietary Powder Blends to Ensure Dependable Ignition



SIG VARMINT & PREDATOR

E223V1-20 / E225V1-20 / E243V1-20 / E300H2-20

- ▲ Match Grade Accuracy
- ▲ Flat Trajectories
- ▲ Explosive Fragmentation on Small Game



COMPONENTS

BAGGED BRASS / PRIMED BAGGED BRASS

Elite Performance Ammunition shell cases are engineered to exacting tolerances and available for multiple pistol and rifle calibers. The geometric consistency of these premium brass cases ensures each primer is held tightly in its pocket. Flash holes are precise with no burrs and the superior metallurgical properties of the SIG SAUER® cases enable repeated reloading. All Elite Performance rifle shell cases are induction annealed for consistent bullet retention.

THE BEST RELOADING BRASS MANUFACTURED IN THE U.S.A.

new

338 NORMA MAG

Bagged Brass



BAGGED BRASS

VARIOUS

- ▲ Engineered for Precision Hand Loaders
- ▲ Exceptional Concentricity of the Mouth for Improved Accuracy
- ▲ Engineered to Exacting Standards; each Brass Case Undergoes Rigorous In-Line and Post-Production, Quality Assurance Testing to Ensure a Flawless Casing
- ▲ Flash Holes are Precise with No Burrs
- ▲ Superior Metallurgical Properties of the SIG SAUER® Cases Enable Repeated Reloading
- ▲ SIG Elite Rifle Shell Cases are Induction Annealed for Consistent Bullet Retention
- ▲ All Shell Cases are 100% Inspected by Advanced Metrology Equipment that Measures every Dimensional Aspect of the Case.



9MM
Primed Bagged Brass

6.5 CREEDMOOR
Bagged Brass

338 NORMA MAG
Bagged Brass

UN-PRIMED

CALIBER	QTY/BAG	SKU
380 AUTO	100	BP1002
9MM	100	BP1003
357 SIG	100	BP1005
38 SPL	100	BP1007
357 MAG	100	BP1008
40 S&W	100	BP1009
10MM	100	BP1010
45 AUTO	100	BP1011
223 REM	100	BR2004
22-250 REM	50	BR2005
243 WIN	50	BR2006
6MM CM	50	BR6MMCM 
6.5 CM	50	BR2011
260 REM	50	BR260REM 
270 WIN	50	BR2018
7MM REM	50	BR2024 
300 BLK	50	BR2029
308 WIN	50	BR2030
30-06 SPG	50	BR2031
300 WIN MAG	50	BR2033
338 NORMA	25	BR338NM 

PRIMED

CALIBER	QTY/BAG	SKU
380 AUTO	100	BP1002P
9MM	100	BP1003P
357 SIG	100	BP1005P
38 SPL	100	BP1007P
357 MAG	100	BP1008P
40 S&W	100	BP1009P
10MM	100	BP1010P
45 AUTO	100	BP1011P

ELECTRO-OPTICS





ELECTRO-OPTICS

SEE THE DIFFERENCE

SIG SAUER® Electro-Optics fuse together advanced electronic technologies, superior, high-definition glass, and military-inspired designs to achieve maximum clarity, accuracy, and performance shot after shot.

Learn more about SIG SAUER Electro-Optics at sigsauer.com/electro-optics



SIG SAUER ELECTRO-OPTIC INFINITE GUARANTEE*

- Unlimited Lifetime Guarantee
- No Warranty Card Required
- No Receipt Required
- No Time Limit Applies
- No Charge
- Fully Transferable



ELECTRONIC AND TRITIUM LIMITED 5-YEAR WARRANTY

Covers any defects in materials and workmanship in the electronic and tritium components of illuminated riflescopes/sights, pistol sights, electronic sights, flashlights, lasers, binoculars, spotting scopes, and rangefinders for five years from the date of manufacture.

EMBEDDED APPLIED BALLISTICS®

ABU Applied Ballistics Ultralight

Applied Ballistics Ultralight is the streamlined ballistic calculator developed with Applied Ballistics and integrated into all BDX products. Ballistic solutions are provided out to a maximum of 800 yards.

ABX Applied Ballistics External

Applied Ballistics external allows external devices such as Kestrel® to compute Applied Ballistics Elite solutions and communicate the firing solution back to select BDX enabled devices.

ABS Applied Ballistics System

Applied Ballistics System embeds Applied Ballistics Elite on-board select products with integral environmental sensors to calculate complete ballistic solutions out to the effective range of any firearm.

Shot on location in the San Juan and Rio Grande National Forests, permission granted under special use authorization.



SBT[®] SIG Ballistic Turret

A Custom, Laser-Etched Elevation Dial on Most SIG SAUER[®] TANGO[®] and WHISKEY[®] Riflescopes

Matched to the Ballistics of the Shooter's System at No Extra Cost

Inputs Bullet Specifications, Ballistic Coefficient, Muzzle Velocity, Elevation, and Other Environmental Factors

Allows for Correct Bullet Drop Compensation and Pinpoint Accuracy at Any Range



LOCKDOWN[®] Zero System

Zero Stop-Locking Turret Allows a Rapid Return to Zero

Eliminates Concern About How Far to Turn the Elevation Dial to Return to Zero



STEALTH ID[™]

Deflection Armor Trapezoidal Surfacing Breaks Up the Shape and Visibility of the Optic

Slide Serrations and Grip Checkering Add Function to the Form of all SIG SAUER Electro-Optics



HELLFIRE[®] Reticle

Electronically Illuminated Utilizing an Advanced Fiber Optic Technology

Varies the Light Intensity of the Central Aiming Point from Night Vision Compatible to HellFire Bright for Daylight Illumination

Results in a Bright, Defined Aiming Point for Precision Shot placement in any condition



LEVELPLEX[™] Digital Anti-Cant System

Utilizes an Integrated Digital Level that is Accurate to +/- 0.5° Available in any WHISKEY5 or TANGO6 with a side focus

Auto Levelplex Mode Calibrates Level Sensitivity to Distance Ranged to Target



MEGAVIEW[™]

Provides Massive Field of View (FOV), Allowing Faster Target Acquisition

Enhances Awareness of Objects in the Shooter's Periphery



ALT[™] Aspheric Lens Technology

Eliminates Aberration, Reduces Weight, and Helps to Focus the Projected Image Through the Lenses

Superior Low Distortion Optical Performance



SPECTRACOAT[™]

Highly Efficient, Ultra-Wide Broadband, Anti-Reflection Lens Coatings

Reduces Surface Reflections to Extremely Low Levels Across the Entire Visible Spectrum

Provides Superior Light Transmission



HDX[®] High Definition Transmittance

Comprises Both High Definition (HD) and High Transmittance (HT) Glass

Ultra-High Resolution, Optical Performance, and Light Transmission



LENSARMOR[™]

Abrasion-Resistant Lens Coatings

Extreme Durability Ensures the Lenses on the Scope Will Stay Sharp, Bright, and Clear



LENSHIELD[™]

Mil-Spec Oleophobic Coating

Sheds Water, Oil, and Gunk, to Ensure a Clean Sight Image at All Times



MOTAC[™] Moton Activated Illumination

Motion-Sensing Technology

Powers Up Illumination When Sensing Motion, and Powers Down When it Does Not, Extending Battery Life



SOLAR POWERED ILLUMINATION

Powered By a Solar Cell

Extends Runtime and Improves Daylight Brightness of the Reticle With or Without a Battery



TRUHold[™]

Lockless Zeroing System

Utilizes Quad Adjustment Springs Designed and Torture-Tested to Endure Handgun Recoil and Return to Zero Shot After Shot



OIS[™] Optical Image Stabilization

Proprietary SIG Optical Image Stabilizer System

Gyroscopically Stabilized to Cancel Out Unwanted Shaking and Vibrations that Can Blur an Image, Especially at Higher Magnification Levels



AMR[™] Angle-Modified Range

Ranging Technology Using an On-Board Inclinometer

Reads Incline / Decline Angle and Modifies the Effective Ballistic Shooting Range to The Target

Equivalent Horizontal Range, that Integrates Perfectly When Used with SIG Ballistic Turret Dials



LIGHTWAVE DSP[™] Digital Signal Processing

Leverages HyperScan, and Advanced Power Management Technique, Providing the Fastest Refresh Rate in Scan Mode (4 times Per Second)

Uses the Latest Generation Field Programmable Gate Array (FPGA)

Reduces false positives while finding weak or distant targets



HYPERSCAN[™]

Features the Fastest, most Accurate Range Acquisition Algorithms by Analyzing Targets 4 Times Per Second and Displaying the Results on Stationary or Moving Targets within a Quarter of a Second.



LUMATIC DISPLAY[™]

Proprietary OLED (Organic Light Emitting Diode) Display Ambient Light Sensor Continuously Monitors Light Conditions and Adjusts the Display Brightness Accordingly

No other Display Offers this Adaptive Ability to Prevent the Shooter's Pupil from Constricting in Low-Light Conditions



90° POWERCAM[™] MOUNT

Quick Flip Away Mount for Fast Transitions from Near to Far Distance Targets

No Button Actuator for Rapid Single-Handed Operation Point for Precision Shot Placement in Any Condition



KinETHIC[™] Kinetic Energy Indicator

KinETHIC Kinetic Energy Indicator

Allows a Hunter to set a Threshold in Either ft-lbs or fps for the Ethical Harvest of Game Animals. BDX will Compute Distance Ranged and Indicate when you Drop Below the user-set Threshold for Energy or Speed of Bullet on Target



BDX 2.0[™]

Software Update that Includes a New Easy Mode for Quick BDX Setup Out of the Box, Including:

BDX kits Come Paired and Bonded

BDX QuickBond[™] System Gives Users the Ability to Bond Two BDX Enabled Devices without the Smartphone App

BDX Equipped KILD[®] Rangefinders Preloaded with Ballistic Groups for Centerfire Rifles, Muzzleloaders, and Crossbows

100% Compatible with BDX Smartphone App to Access the Advanced BDX Features in Configuration Options



WGP[™] Weapons Grade Polymer

Optimized for use with Polymer Pistols

Lightweight Textured Polymer

BDX 2.0™



Ballistic Data Storage

Powered by:



WHAT IS BDX?

SIG SAUER® has built on the success of BDX, adding features and benefits that allow hunters and shooters to 'hit the ground running' with their BDX systems. All BDX rangefinders now come preprogrammed with 9 ballistic profiles that cover most centerfire rifle cartridges, as well as crossbows and muzzleloaders. BDX combo kits will now come pre-bonded from the factory. All users have to do to use their systems now is mount and zero their riflescopes. If users want to unlock the complete feature set of BDX, they are still able to do this via the smartphone app.

BDX RANGEFINDER

BDX kits come pre-bonded right out of the box

When purchasing a rangefinder and riflescope together there is no setup necessary. Simply mount and zero your riflescope and you are ready to go.

QuickBond™ for app-less bonding of BDX equipped rangefinders and sights

There is no need for the smartphone app to connect your BDX devices.

Simply press and hold two buttons and your BDX rangefinder will bond with the nearest BDX enabled sight.

Pre-loaded ballistic groups now available on KILO® BDX rangefinders to quickly get you on target

Every BDX rangefinder now comes preloaded with 9 distinct ballistic groups. These groups represent the ballistics for each popular centerfire caliber available, as well as crossbows and muzzleloaders. Simply pick the group that matches your caliber.

Download the BDX app to unlock the full advanced capabilities and features of the BDX system

Setup a custom profile utilizing the Applied Ballistics® bullet library and the exact muzzle velocity of your firearm. BDX will do the rest.

BDX RIFLESCOPE

The powerful SIERRA3BDX and SIERRA6BDX riflescopes revolutionize the art of holdover calculation. Again, set your ballistic profile in the SIG BDX app, sync the app with your riflescope and then configure multiple holdover points in the digital ballistic reticle. When you view your target through the reticle each of your exact holdover points is illuminated. No more turrets to adjust or calculations to make.

BDX SYSTEMS

When used together, KILO BDX rangefinders and SIERRA3BDX riflescopes combine to create the most advanced optics system available on the market today. Simply configure your ballistics profile in the BDX app, pair your KILO BDX rangefinder with the app, and then bond it to your SIERRA3BDX riflescope. When you range your target the KILO BDX rangefinder automatically sends your specific holdover data to your SIERRA3BDX riflescope giving you an illuminated holdover dot. It's simple and fast.

CONNECT THE DOT®.

Learn more about the BDX System at sigsauer.com/electro-optics

THE WORLD'S MOST ADVANCED...

RIFLESCOPES

- ▲ BDC Reticle is Customized to Shooter's Ballistics and Environmental Profile Prior to Hunting
- ▲ BDC Reticle can be set with Up to Eight Holdover Dots at Any Distances Out to 800 Yards
- ▲ Digital Focal Plane™ Reticle Scales with Zoom like a First Focal Plane Rifle Scope
- ▲ HD Glass and Spectracoat™ Lens Coatings
- ▲ Levelplex™ Digital Anti-Cant System



RANGEFINDERS

- ▲ Embedded Applied Ballistics® Ultralite Engine with Extensive Bullet Library with Support for G1/G7 Drag Curves
- ▲ Save up to 25 Custom Ballistic Profiles in the SIG BDX App
- ▲ Active Ballistic Profile and Environmental Sync to Rangefinder
- ▲ Windage and Elevation Holds in MOA or MILS with Every Target Ranged
- ▲ Lightwave DSP™ leverages 4x/Second HyperScan and RangeLock Technologies for the Fastest Ranging Performance



OPTICS SYSTEM

SIG SAUER® Electro-Optics transforms hunting with the unprecedented simplicity and accuracy of BDX. KILO® BDX rangefinders use your ballistics and Bluetooth® to illuminate the exact holdover dot in SIERRA3BDX riflescopes. For the most accurate and ethical shot, just **CONNECT THE DOT®**.



ELECTRO-OPTICS

BDX 2.0™



Shot on location in the San Juan and Rio Grande National Forests, permission granted under special use authorization.





SIERRA6™ BDX®

RIFLESCOPES WITH BALLISTIC DATA XCHANGE

Built upon SIERRA3 award-winning technology, and the SIG SAUER® BDX Ballistic Data Xchange technology, the SIERRA6 family of riflescopes provides the hunter or marksmen with an intelligent auto-holdover specific to their ballistics, target, and environment. Pairing a SIERRA6 to a BDX equipped rangefinder allows users to bring the capability of Applied Ballistics® into the field without the need for a mobile device.

STANDARD FEATURES

- ▲ Integrated BDX Ballistic Data Xchange 2.0 with Up to 95% Light Transmission
- ▲ Advanced HDX® 6x Optical System
- ▲ Automatic Hold-over Dot on a Digital Focal Plane
- ▲ Ballistic Profiles Compatible with Centerfire, Muzzleloader, and Crossbow Platforms
- ▲ Innovative KinETHIC™ Kinetic Energy Transfer Indicator for Ethical Shots
- ▲ Dependable Waterproof and Fog-Proof Performance (IPX-7 for Complete Immersion up to 1 Meter)
- ▲ Argon Purged for an Enhanced Lifetime of Performance
- ▲ Levelplex™ with Auto Levelplex Mode



Ballistic Data Xchange



SIERRA6BDX 5-30X56

34MM MAINTUBE
SOSBDX65111

- ▲ Digital Focal Plane BDX-R2 Reticle
- ▲ Seamlessly Pairs with BDX Enabled Devices to Provide Exact Hold-overs Based on Measured Target Distances
- ▲ User-Customizable Ballistic Data Provides Hold-over Dots
- ▲ Side Focus Allows Users to Remove Parallax
- ▲ Blue LED on Eye Piece Indicates when Bluetooth® is Paired to KIL0® BDX Rangefinder
- ▲ HDX Glass and Coatings for the Best Optical Quality in its Class



SIERRA6BDX 3-18X44

30MM MAINTUBE
SOSBDX63111

- ▲ Digital Focal Plane BDX-R2 Reticle
- ▲ Seamlessly Pairs with BDX Enabled Devices to Provide Exact Holdovers Based on Measured Target Distances
- ▲ User-Customizable Ballistic Data Provides Hold-over Dots
- ▲ Side Focus Allows Users to Remove Parallax
- ▲ Blue LED on Eye Piece Indicates when Bluetooth is Paired to KIL0 BDX Rangefinder
- ▲ HDX Glass and Coatings for the Best Optical Quality in its Class



SIERRA6BDX 2-12X40

30MM MAINTUBE
SOSBDX62111

- ▲ Digital Focal Plane BDX-R2 Reticle
- ▲ Seamlessly Pairs with BDX Enabled Devices to Provide Exact Holdovers Based on Measured Target Distances
- ▲ User-Customizable Ballistic Data Provides Hold-over Dots
- ▲ Blue LED on Eye Piece Indicates when Bluetooth is Paired to KIL0 BDX Rangefinder
- ▲ HDX Glass and Coatings for the Best Optical Quality in its Class

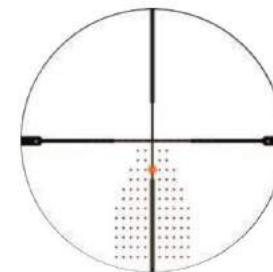

The BDX-R2 Digital Ballistic Reticle GEN II High Resolution LED display doubles the amount of available hold-over dots giving users greater accuracy and resolution to each shot. The reticle has aiming aids to help align elevation and wind indicators.



Blue LED flashes with each reticle update



Shot on location in the San Juan and Rio Grande National Forests, permission granted under special use authorization.

SIERRA3 BDX[®]

RIFLESCOPES WITH BALLISTIC DATA XCHANGE

Disguised within the form factor of a traditional riflescope lies the power of the SIG SAUER[®] BDX Ballistic Data Xchange. The SIERRA3BDX riflescope provides the hunter with an illuminated auto-holdover dot on targets when coupled with a BDX-capable KILO[®] rangefinder.

STANDARD FEATURES

- ▲ Integrated BDX Ballistic Data Xchange 2.0
- ▲ Automatic Holdover Dot on a Digital Focal Plane
- ▲ Ballistic Profiles Compatible with Centerfire, Muzzleloader, and Crossbow Platforms
- ▲ Innovative KinETHIC[™] Kinetic Energy Transfer Indicator
- ▲ Dependable Waterproof and Fog-Proof Performance (IPX-7 for Complete Immersion up to 1 Meter)
- ▲ Levelplex[™] with Auto Levelplex mode



Ballistic Data Xchange



SIERRA3BDX 6.5-20X52

30MM MAINTUBE
SOSBDX36111

- ▲ Provides Holdover Dot for Hunting out to 800 yards
- ▲ Digital Focal Plane BDX-R1 Reticle Subtensions Correct with Zoom
- ▲ Blue LED on Power Selector Indicates when Bluetooth[®] is Paired to KILO BDX Rangefinder
- ▲ HD Glass and Coatings for the Best Optical Quality in its Class



BDX-R1 Digital Ballistic Reticle



Blue LED flashes with each reticle update



SIERRA3BDX 4.5-14X50

30MM MAINTUBE
SOSBDX34112

- ▲ Provides Holdover Dot for Hunting out to 800 Yards.
- ▲ Digital Focal Plane BDX-R1 Reticle Subtends with Zoom
- ▲ Blue LED on Power Selector Indicates when Bluetooth[®] is Paired to KILO BDX Rangefinder
- ▲ HD Glass and Coatings for the Best Optical Quality in its Class



SIERRA3BDX 4.5-14X44

30MM MAINTUBE
SOSBDX34111

- ▲ Provides Holdover Dot for Hunting out to 800 Yards
- ▲ Digital Focal Plane BDX-R1 Reticle Subtends with Zoom
- ▲ Blue LED on Power Selector Indicates when Bluetooth is Paired to KILO BDX Rangefinder
- ▲ HD Glass and Coatings for the Best Optical Quality in its Class



SIERRA3BDX 3.5-10X42

30MM MAINTUBE
SOSBDX33111

- ▲ Provides Holdover Dot for Hunting out to 800 Yards
- ▲ Digital Focal Plane BDX-R1 Reticle Subtends with Zoom
- ▲ Blue LED on Power Selector Indicates when Bluetooth is Paired to KILO BDX Rangefinder
- ▲ HD Glass and Coatings for the Best Optical Quality in its Class



SIERRA3BDX 2.5-8X32

30MM MAINTUBE
SOSBDX32111

- ▲ Provides Holdover Dot for Hunting out to 800 Yards
- ▲ Digital Focal Plane BDX-R1 Reticle Subtends with Zoom
- ▲ Blue LED on Power Selector Indicates when Bluetooth is Paired to KILO BDX Rangefinder
- ▲ HD Glass and Coatings for the Best Optical Quality in its Class

ELECTRO-OPTICS



KILO3000BDX™

BDX® BALLISTIC DATA XCHANGE LASER RANGEFINDER

Featuring SIG SAUER BDX technology, the KILO3000BDX is one of the world's most advanced laser rangefinders. When paired with a BDX enabled product, the onboard Applied Ballistics® Ultralite calculator sends ballistic drop data via Bluetooth® directly to the BDX sight, providing an illuminated holdover dot and wind hold. Download the free BDX App for iOS or Android to setup ballistic profiles and synchronize custom profiles to your KILO® for exact ballistic solutions.

STANDARD FEATURES

- ▲ Will Range Up to 5,000 yards with Results Displayed to the Nearest 1/10th Yard
- ▲ Lumatic OLED Display, Continuously Monitors Light Conditions & Adjusts the Display Brightness Accordingly
- ▲ Multi-Position Twist-Up Eyecups Provide a Custom Fit for Each User
- ▲ Compact, Lightweight Aluminum Housing with Dual Diopter Adjustment
- ▲ User-Selectable Target Modes Featuring LAST or BEST Mode for Pinpoint Accuracy
- ▲ Powered by a Lithium CR2 Battery
- ▲ FOV = 32 ft/100 Yards / 6.1 Degrees



Ballistic Data Xchange



2019
ICA

2019 INDUSTRY CHOICE AWARDS

Optic of the Year: KILO3000BDX Rangefinder Binoculars

Powered by:



DISPLAY

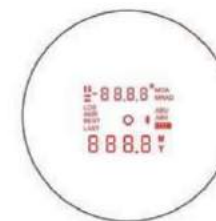

RANGES

Up to
1500 YDS
DEER

Up to
2000 YDS
TREES

Up to
5000 YDS
REFLECTIVE

KILO3000BDX BINOCULAR RANGEFINDER

10X42MM
SOK31001

- ▲ BDX™ Ballistic Data Xchange Capable, Providing your BDX Rifle Scope with an Automatic Illuminated Holdover Dot through Bluetooth® Pairing
- ▲ Supports Applied Ballistics® External for Pairing your KILO with a Kestrel® with Onboard Applied Ballistics Elite™
- ▲ Revolutionary Lightwave DSP™ Technology for the Fastest and Longest Distance Rangefinder Engine
- ▲ HyperScan™ Technology Provides 4 Range Updates Per Second in Scan Mode while RangeLock™ Reports the Last Range Result when Ranging Distant Targets
- ▲ Embedded Applied Ballistics Ultralite™ with Bullet Database and Support for G1/G7 Drag Curves
- ▲ Fully Multi-Coated ED Glass Lenses and Phase-Coated Prisms for High Resolution and High Contrast

KILO® BDX™

BDX BALLISTIC DATA XCHANGE LASER RANGEFINDER

Featuring SIG SAUER BDX technology, the KILO BDX series of rangefinders are the world's most advanced laser rangefinders. When paired with a BDX enabled product, the onboard Applied Ballistics® Ultralite calculator sends ballistic drop data via Bluetooth® directly to the BDX sight, providing an illuminated holdover dot and wind hold. Download the free BDX App for iOS or Android to setup ballistic profiles and synchronize custom profiles to your KILO for exact ballistic solutions.



Ballistic Data Xchange

STANDARD FEATURES

- ▲ 4x Per Second Scan Rate
- ▲ Low-Energy Bluetooth
- ▲ User-Selectable Target Modes Featuring LAST or BEST Mode for Pinpoint Accuracy
- ▲ Powered by Lithium CR2 Battery



KILO2400BDX™ BINOCULAR RANGEFINDER

7X25MM
SOK24704

- ▲ BDX™ Ballistic Data Xchange Capable. Providing your BDX Riflescope with an Automatic Illuminated Holdover Dot Through Bluetooth Pairing
- ▲ Embedded Applied Ballistics® Ultralite with Bullet Database and Support for G1/G7 Drag Curves
- ▲ Supports Applied Ballistics External for Pairing your KILO with a Kestrel® with Onboard Applied Ballistics Elite
- ▲ Low Energy Bluetooth 4.0 for Synchronizing up to 25 Custom Ballistic Profiles Between the Free SIG Ballistic App and Rangefinder
- ▲ Advanced OLED Display Provides a Smaller, Extremely Precise Targeting Circle along with Milling Features and Ballistic Info Including Holdover Angle, Target Mode, and Shot Angle

RANGES

Up to
1400 YDS
DEER

Up to
1800 YDS
TREES

Up to
3400 YDS
REFLECTIVE

Powered by:





KILO®

	MAG	OBJECTIVE CLEAR APERTURE	EXIT PUPIL	EYE RELIEF	ANGULAR (FOV)	RANGE RESPONSE TIME	LASER DIVERGENCE	SCAN RATE	UNDER 100 YDS ACCURACY	MAX RANGE REFLECTIVE	MAX RANGE DEER	MAX RANGE TREES	WEIGHT
KILO2400BDX™ SOK24704	7x	25 mm	3.6 mm	15 mm	6.78"	0.25 sec	1.4 MRAD	4x Per Second	+/- 0.1 yds	Up To 3400 yds	Up To 1400 yds	Up To 1800 yds	7.5 oz / 215 g
KILO2200BDX™ SOK22704	7x	25 mm	3.6 mm	15 mm	6.78"	0.25 sec	1.4 MRAD	4x Per Second	+/- 0.1 yds	Up To 3400 yds	Up To 1300 yds	Up To 1600 yds	7.5 oz / 215 g
KILO1800BDX™ SOK18601 (CLASS 3R) / SOK18602 (CLASS 1M)	6x	22 mm	3.7 mm	17 mm	6.0"	0.25 sec	1.3 MRAD	4x Per Second	+/- 0.1 yds	Up To 2000 yds	Up To 1000 yds	Up To 1200 yds	7.9 oz / 225 g
KILO1600BDX™ SOK16607	6x	22 mm	3.7 mm	17 mm	6.0"	0.25 sec	4.0 MRAD	4x Per Second	+/- 0.1 yds	Up To 2000 yds	Up To 1000 yds	Up To 1200 yds	6.4 oz / 181 g
KILO1400BDX™ SOK14601	6x	20 mm	3.3 mm	15 mm	6.5"	0.25 sec	3.33 MRAD	4x Per Second	+/- 0.1 yds	Up To 1600 yds	Up To 750 yds	Up To 950 yds	5.3 oz / 150 g
KILO1000BDX™ SOK10602	5x	20 mm	4.0 mm	18 mm	7.50"	0.25 sec	2.00 MRAD	4x Per Second	+/- 0.1 yds	Up To 1200 yds	Up To 800 yds	Up To 1000 yds	5.2 oz / 147 g

BDX 2.0™ COMBO KITS

BDX DIGITAL BALLISTIC XCHANGE SYSTEMS

Ultimate BDX value kits come with SIERRA3BDX riflescope and a KILO® BDX rangefinder. Simply download the SIG BDX App, set up your ballistic profile, pair your new BDX rangefinder and riflescope, and go hunt.

COMBO KIT KILO2400BDX™ / SIERRA3BDX™ 6.5-20X52

SOK24BDX01

KILO2400BDX

- ▲ BDX™ Ballistic Data Xchange Capable. Providing your BDX Riflescope with an Automatic Illuminated Holdover Dot Through Bluetooth® Pairing
- ▲ Embedded Applied Ballistics® Ultralite with Bullet Database and Support for G1/G7 Drag Curves
- ▲ Supports Applied Ballistics External for Pairing your KILO Rangefinder with a Kestrel® with Onboard Applied Ballistics Elite
- ▲ Low Energy Bluetooth 4.0 for Synchronizing up to 25 Custom Ballistic Profiles Between the Free SIG Ballistic App and Rangefinder
- ▲ Advanced OLED Display Information. Provides a Smaller, Extremely Precise Targeting Circle along with Milling Features and Ballistic Info Including Holdover Angle, Target Mode, and Shot Angle

SIERRA3BDX

- ▲ Provides Holdover Dot for Hunting out to 800 Yards.
- ▲ Digital Focal Plane BDX-R1 Reticle Subtends with Zoom
- ▲ Blue LED on Power Selector Indicates when Bluetooth is Paired to KILO BDX Rangefinder
- ▲ HD Glass and Coatings for the Best Optical Quality in its Class
- ▲ Integrated BDX Ballistic Data Xchange.
- ▲ Automatic Holdover Dot on a Digital Focal Plane
- ▲ Innovative KinETHIC™ Kinetic Energy Transfer Indicator

Powered by:



RANGES	Up to 1400 YDS DEER	Up to 1800 YDS TREES	Up to 3400 YDS REFLECTIVE
--------	---------------------	----------------------	---------------------------

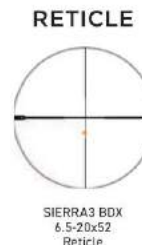

GUNS AND AMMO MAGAZINE Innovation of the year award

Recognizing new product with demonstrated quality and reliability that appeals to the masses.

SIG SAUER® Electro-Optics Ballistic Data Xchange (BDX) Rangefinder and Riflescope System.



COMBO KITS

KILO1600BDX / SIERRA6BDX 2-12X40 SOK16BDX61
KILO2200BDX / SIERRA6BDX 3-18X44 SOK22BDX61
KILO2400BDX / SIERRA6BDX 5-30X56 SOK24BDX61
KILO1000BDX / SIERRA3BDX 2.5-8X32 SOK10BDX01
KILO1000BDX / SIERRA3BDX 3.5-10X42 SOK10BDX02
KILO1000BDX / SIERRA3BDX 4.5-14X44 SOK10BDX03
KILO1400BDX / SIERRA3BDX 3.5-10X42 SOK14BDX01
KILO1600BDX / SIERRA3BDX 2.5-8X32 SOK16BDX01
KILO1600BDX / SIERRA3BDX 3.5-10X42 SOK16BDX02
KILO1600BDX / SIERRA3BDX 4.5-14X44 SOK16BDX03
KILO1600BDX / SIERRA3BDX 4.5-14X50 SOK16BDX04
KILO1600BDX / SIERRA3BDX 6.5-20X52 SOK16BDX05
KILO1800BDX / SIERRA3BDX 4.5-14X44 SOK18BDX01
KILO2200BDX / SIERRA3BDX 4.5-14X50 SOK22BDX01
KILO2400BDX / SIERRA3BDX 6.5-20X52 SOK24BDX01

SIERRA® BDX 2.0™

KILO®

MAG	OBJECTIVE	RETICLE	ADJUSTMENTS	BATT	MAIN TUBE	LENGTH	WEIGHT	MAG	OBJECTIVE CLEAR APERTURE	EXIT PUPIL	EYE RELIEF	ANGULAR (FOV)	RANGE RESPONSE TIME	LASER DIVERGENCE	SCAN RATE	UNDER 100 YDS Resolution	MAX RANGE REFLECTIVE	MAX RANGE DEER	MAX RANGE TREES	WEIGHT
2-12	40	BDX-R2 Digital Focal Plane OLED	0.25 MOA	CR2031 (2)	30 mm	10.75"	21.4 oz	6x	22 mm	3.7 mm	17 mm	6.0°	0.25 sec	4.0 MRAD	4x Per Second	+/- 0.1 yds	Up To 2000 yds	Up To 1000 yds	Up To 1200 yds	6.4 oz / 181 g
3-18	44	BDX-R2 Digital Focal Plane OLED OLED Ballistic Side Focus	0.25 MOA	CR2031 (2)	30 mm	12.25"	23.8 oz	7x	25 mm	3.6 mm	15 mm	6.78°	0.25 sec	1.4 MRAD	4x Per Second	+/- 0.1 yds	Up To 3400 yds	Up To 1300 yds	Up To 1600 yds	7.5 oz / 212 g
5-30	56	BDX-R2 Digital Focal Plane OLED OLED Ballistic Side Focus	0.25 MOA	CR2031 (2)	34 mm	14.75"	30.4 oz	7x	25 mm	3.6 mm	15 mm	6.78°	0.25 sec	1.4 MRAD	4x Per Second	+/- 0.1 yds	Up To 3400 yds	Up To 1400 yds	Up To 1800 yds	7.5 oz / 212 g
2.5-8	32	BDX-R1 OLED Ballistic	0.25 MOA	CR2031 (2)	30 mm	11.6"	19.4 oz	5x	20 mm	4.0 mm	18 mm	7.50°	0.25 sec	2.0 MRAD	4x Per Second	+/- 0.1 yds	Up To 1200 yds	Up To 800 yds	Up To 1000 yds	5.2 oz / 147 g
3.5-10	42	BDX-R1 OLED Ballistic	0.25 MOA	CR2031 (2)	30 mm	12.75"	20.9 oz	5x	20 mm	4.0 mm	18 mm	7.50°	0.25 sec	2.0 MRAD	4x Per Second	+/- 0.1 yds	Up To 1200 yds	Up To 800 yds	Up To 1000 yds	5.2 oz / 147 g
4.5-14	44	BDX-R1 OLED Ballistic Side Focus	0.25 MOA	CR2031 (2)	30 mm	12.60"	23.2 oz	5x	20 mm	4.0 mm	18 mm	7.50°	0.25 sec	2.0 MRAD	4x Per Second	+/- 0.1 yds	Up To 1200 yds	Up To 800 yds	Up To 1000 yds	5.2 oz / 147 g
3.5-10	42	BDX-R1 OLED Ballistic	0.25 MOA	CR2031 (2)	30 mm	12.75"	20.9 oz	6x	20 mm	3.3 mm	15 mm	6.5°	0.25 sec	3.33 MRAD	4x Per Second	+/- 0.1 yds	Up To 1600 yds	Up To 750 yds	Up To 950 yds	5.0 oz / 140 g
2.5-8	32	BDX-R1 OLED Ballistic	0.25 MOA	CR2031 (2)	30 mm	11.6"	19.4 oz	6x	22 mm	3.7 mm	17 mm	6.0°	0.25 sec	4.0 MRAD	4x Per Second	+/- 0.1 yds	Up To 2000 yds	Up To 1000 yds	Up To 1200 yds	5.0 oz / 142www g
3.5-10	42	BDX-R1 OLED Ballistic	0.25 MOA	CR2031 (2)	30 mm	12.75"	20.9 oz	6x	22 mm	3.7 mm	17 mm	6.0°	0.25 sec	4.0 MRAD	4x Per Second	+/- 0.1 yds	Up To 2000 yds	Up To 1000 yds	Up To 1200 yds	6.4 oz / 181 g
4.5-14	44	BDX-R1 OLED Ballistic Side Focus	0.25 MOA	CR2031 (2)	30 mm	12.60"	23.2 oz	6x	22 mm	3.7 mm	17 mm	6.0°	0.25 sec	4.0 MRAD	4x Per Second	+/- 0.1 yds	Up To 2000 yds	Up To 1000 yds	Up To 1200 yds	6.4 oz / 181 g
4.5-14	50	BDX-R1 OLED Ballistic Side Focus	0.25 MOA	CR2031 (2)	30 mm	12.75"	24.9 oz	6x	22 mm	3.7 mm	17 mm	6.0°	0.25 sec	4.0 MRAD	4x Per Second	+/- 0.1 yds	Up To 2000 yds	Up To 1000 yds	Up To 1200 yds	6.4 oz / 181 g
6.5-20	52	BDX-R1 OLED Ballistic Side Focus	0.25 MOA	CR2031 (2)	30 mm	14.3"	25.9 oz	6x	22 mm	3.7 mm	17 mm	6.0°	0.25 sec	4.0 MRAD	4x Per Second	+/- 0.1 yds	Up To 2000 yds	Up To 1000 yds	Up To 1200 yds	6.4 oz / 181 g
4.5-14	44	BDX-R1 OLED Ballistic Side Focus	0.25 MOA	CR2031 (2)	30 mm	12.60"	23.2 oz	6x	22 mm	3.7 mm	17 mm	6.0°	0.25 sec	1.3 MRAD	4x Per Second	+/- 0.1 yds	Up To 2000 yds	Up To 1000 yds	Up To 1200 yds	7.9 oz / 224 g
4.5-14	50	BDX-R1 OLED Ballistic Side Focus	0.25 MOA	CR2031 (2)	30 mm	12.75"	24.9 oz	7x	25 mm	3.6 mm	15 mm	6.78°	0.25 sec	1.4 MRAD	4x Per Second	+/- 0.1 yds	Up To 3400 yds	Up To 1300 yds	Up To 1600 yds	7.5 oz / 212 g
6.5-20	52	BDX-R1 OLED Ballistic Side Focus	0.25 MOA	CR2031 (2)	30 mm	14.25"	25.9 oz	7x	25 mm	3.6 mm	15 mm	6.78°	0.25 sec	1.4 MRAD	4x Per Second	+/- 0.1 yds	Up To 3400 yds	Up To 1400 yds	Up To 1800 yds	7.5 oz / 212 g

ELECTRO-OPTICS



TANGO6T OPTIC HAS BEEN SELECTED BY:

- The U.S. ARMY Squad Designated Marksman Rifle (SDMR)
- USSOCOM Squad-Variable Powered Scope (S-VPS)
- The U.S. Air Force

TANGO6T™

THE CHOICE OF THE U.S. ARMY AND SPECIAL OPERATIONS

TANGO6T riflescopes have been selected by the US Army and USSOCOM to deliver unmatched performance and optical clarity when it matters most. TANGO6T riflescopes are MIL-STD810G tested and approved and are assembled in the U.S.A.

STANDARD FEATURES

- ▲ 6x Super-Zoom Advanced Optical System
- ▲ First and Second Focal Plane Reticles
- ▲ Throwlever Included with all SKUs
- ▲ Fast Focus Eyepiece
- ▲ Waterproof (IPX-8 rated) and Fog-Proof Performance
- ▲ Night Vision Illuminated Reticle Settings with Locking Dial
- ▲ Laser Engraved Mounting Line to Align Rifle Scope to Scope Rings
- ▲ Flat Dark Earth (FDE) or Black Anodize Finish Options
- ▲ Assembled in the U.S.A.



TANGO6T 1-6X24 FFP

30MM MAINTUBE
SOT61231 / SOT61131 / SOT61234 / SOT61134 / SOT61239

- ▲ Designed for MSR/AR Platforms
- ▲ Ideal for Close to Mid-Range Tactical Engagements.
- ▲ Fiber Optic Power Indicator
- ▲ Multiple Reticle Options Available
- ▲ Daylight Bright Illumination with Locking Illumination Dial

1-6X24MM

- 5.56/7.62 Horseshoe Dot FFP
- 7.62 Extended Range
- DWLR6 FFP
- M855A1 HELLFIRE
- MOA Milling HELLFIRE
- 3 Gun HELLFIRE



TANGO6T 1-6X24 SFP

30MM MAINTUBE
SOT61233 / SOT61236 / SOT61238 / SOT61138

- ▲ Designed for MSR/AR Platforms
- ▲ Ideal for Close to Mid-Range Tactical Engagements.
- ▲ Fiber Optic Power Indicator
- ▲ Multiple Reticle Options Available
- ▲ Hellfire® Reticles: Fiber Optics to Vary Intensity of Central Aiming Point (SFP)
- ▲ Daylight Bright Illumination with Locking Illumination Dial

Available in
FDE

RETICLES

FFP™



5.56MM / 7.62MM
300 Blackout
Horseshoe Dot

FFP™



7.62
Extended
Range

FFP™

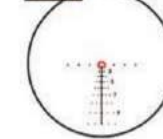

DWLR6

FFP™



M855A1
HELLFIRE®



MOA MILLING
HELLFIRE



3-Gun
HELLFIRE



TANGO6™

PRECISION TACTICAL RIFLESCOPES

The TANGO6 super-zoom 6x riflescope family has you covered for mid to long-range engagements, precision rifle competitions to big game hunting. From bolt actions to MSR's, the TANGO6 is built for versatility.

STANDARD FEATURES

- ▲ 6x Super-Zoom Advanced Optical System
- ▲ Sunshade Included
- ▲ Fast Focus Eyepiece
- ▲ Hellfire® Reticles: Fiber Optics to Vary Intensity of Central Aiming Point
- ▲ Waterproof (IPX-7 rated) and Fog-Proof Performance
- ▲ T-120 Tactical Turret with 120 Clicks Per Revolution

FREE CUSTOM SBT®
WITH SELECT TANGO6™ PURCHASES



Levelplex Digital Anti-Cant System utilizes an integrated digital level with user selectable reticle cant detection at +/- 0.5° or +/-1° sensitivity.

TANGO6 5-30X56 WITH LEVELPLEX™

34MM MAINTUBE
SOT65111 / SOT65112 / SOT65113 / SOT65114

- ▲ Designed for MSR/AR and Bolt Action Platforms
- ▲ Long-Range Precision Shooting, Tactical Engagements and Long-Range Hunting
- ▲ Fiber Optic Power Indicator
- ▲ Offered in FFP with Multiple Reticle Options
- ▲ Levelplex Anti-Cant System



TANGO6 3-18X44 WITH LEVELPLEX

34MM MAINTUBE
SOT63111 / SOT63112 / SOT63113 / SOT63114

- ▲ Designed for MSR/AR and Bolt Action Platforms
- ▲ Ideal for Mid-Range Tactical Engagements and Hunting
- ▲ Offered in FFP with Multiple Reticle Options
- ▲ Levelplex Anti-Cant System

HDX®

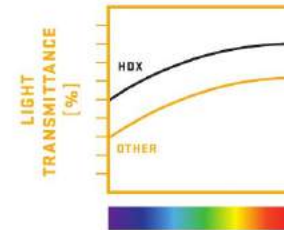

Advanced optical systems comprising both High Definition (HD) and High Transmittance (HT) glass for ultra-high resolution, optical performance, and light transmission.

RETICLES



MOA/MRAD MILLING



MOA/MRAD DEV-L

3-18X44MM

DEV-L MOA Milling, FFP
DEV-L MRAD Milling, FFP
MOA Milling, FFP
MRAD Milling, FFP

5-30X56MM

DEV-L MOA Milling, FFP
DEV-L MRAD Milling, FFP
MOA Milling, FFP
MRAD Milling, FFP



TANGO4™

LONG RANGE PRECISION RIFLESCOPES

With a 4x zoom first-focal plane design, illuminated glass reticles, and revolutionary resettable zero turret, TANGO4 riflescopes are the ideal solution for mid to long-range tactical engagements, designated marksmen, competitive shooters, and hunters.

STANDARD FEATURES

- ▲ 4x Super-Zoom Advanced Optical System
- ▲ Lensarmor™: Abrasion-Resistant Lens Coatings
- ▲ Built-in Throw Lever Included
- ▲ Resettable Zero Turret
- ▲ Low Dispersion (LD) Glass Provides Optical Clarity for any Situation
- ▲ Lenshield™: Proprietary Mil-Spec Oleophobic Coating for Clean Images
- ▲ Waterproof (IPX-7 rated) and Fog-Proof Performance
- ▲ Stealth ID™: Deflection Armor Surfacing for Less Detection



TANGO4 6-24X50 RIFLESCOPE

30MM MAINTUBE
SOT46111 / SOT46112 / SOT46113 / SOT46114

- ▲ Designed for MSR/AR and Bolt Action Platforms
- ▲ Long-Range Precision Shooting, Tactical Engagements and Long-Range Hunting
- ▲ Fiber Optic Power Indicator
- ▲ Offered in FFP with Multiple Reticle Options
- ▲ Lockdown® Zero System



TANGO4 4-16X44

30MM MAINTUBE
SOT44111 / SOT44112 / SOT44113 / SOT44114

- ▲ Designed for MSR/AR and Bolt Action Platforms
- ▲ Mid to Long-Range Tactical Engagements, Designated Marksmen, and Hunting
- ▲ Offered in FFP with Multiple Reticle Options
- ▲ Lockdown Zero System



TANGO4 1-4X24

30MM MAINTUBE
SOT41111 / SOT41112 / SOT41113 / SOT41114

- ▲ Designed for MSR/AR and Bolt Action Platforms
- ▲ Ideal for CQB / Mid-Range Tactical Engagements, 3-Gun Competitions, and Hunting
- ▲ Offered in FFP with Multiple Reticle Options

RETICLES

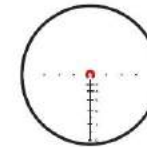

5.56mm / 7.62mm
300 Blackout
Horseshoe Dot

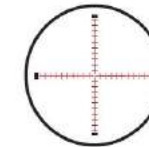

MOA/MRAD MILLING

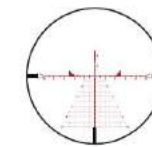

MOA/MRAD
DEV-L

1-4X24 MM

3-12X42 MM

4-16X44 MM

6-24X50 MM

5.56/7.62 Horseshoe Dot FFP
300 Blackout Horseshoe Dot FFP
MOA Milling, FFP
MRAD Milling, FFP
DEV-L MOA Milling, FFP
DEV-L MRAD Milling, FFP
MOA Milling, FFP
MRAD Milling, FFP



Shot on location in the San Juan and Rio Grande National Forests, permission granted under special use authorization.

WHISKEY5™

PRECISION TACTICAL HUNTER RIFLESCOPES

Built to perform in the toughest hunting conditions, the WHISKEY5 super-zoom 5x riflescope line from SIG SAUER® brings the hardest of targets into sharp focus and features the proprietary HDX® optical system, for extreme clarity and low-light performance, and Hellfire® fiber optic illuminated reticles.

STANDARD FEATURES

- ▲ 5x Super-Zoom Advanced Optical System
- ▲ Stealth ID™: Deflection Armor Surfacing
- ▲ Spectracoat™: Reduces Surface Reflections
- ▲ HDX Optics: Unequaled Light Transmission and Optical Clarity
- ▲ Hellfire Reticles: Fiber Optics to Vary Intensity of Central Aiming Point
- ▲ Lenshield™: Proprietary Mil-Spec Oleophobic Coating for Clean Images
- ▲ Waterproof (IPX-7 rated) and Fog-Proof Performance
- ▲ Fast Focus Eyepiece
- ▲ Offered in Second Focal Plane (SFP) and Multiple Reticles



2019 OUTDOOR LIFE AWARDS
Editor's Choice Riflescopes



WHISKEY5 5-25X52 RIFLESCOPE WITH LEVELPLEX™

30MM MAINTUBE
SOW55011 / SOW55017 / SOW55014

- ▲ Designed for Traditional / Dangerous Game Hunting and MSR/AR Platforms
- ▲ Long Range Precision Shooting, and Long Range Hunting
- ▲ Fiber Optic Power Indicator
- ▲ Offered in SFP with Multiple Reticle Options
- ▲ Levelplex Anti-Cant System

RETICLES



HELLFIRE
QUADPLEX®



HELLFIRE
TRIPLEX®

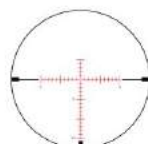

MRAD Milling
Hunter



MOA Milling
Hunter



WHISKEY5 3-15X52MM WITH LEVELPLEX™

30MM MAINTUBE
SOW53013 / SOW53016 / SOW53018

- ▲ Designed for Traditional / Dangerous Game Hunting and MSR/AR Platforms
- ▲ Medium to Long Range Scenarios Across a Wide Range of Calibers
- ▲ Offered in SFP with Multiple Reticle Options
- ▲ Levelplex Anti-Cant System



WHISKEY5 3-15X44MM WITH LEVELPLEX

30MM MAINTUBE
SOW53011 / SOW53017 / SOW53015

- ▲ Designed for Traditional / Dangerous Game Hunting and MSR/AR Platforms
- ▲ Medium to Long Range Scenarios Across a Wide Range of Calibers
- ▲ Offered in SFP with Multiple Reticle Options
- ▲ Levelplex Anti-Cant System



WHISKEY5 2.4-12X56MM WITH LEVELPLEX

30MM MAINTUBE
SOW52015 / SOW52018

- ▲ Designed for Traditional / Dangerous Game Hunting and MSR/AR Platforms
- ▲ European Hunting at Short to Medium Range Low Light Scenarios Across a Wide Range of Calibers
- ▲ Offered in SFP with Multiple Reticle Options
- ▲ Levelplex Anti-Cant System



WHISKEY5 2-10X42MM

30MM MAINTUBE
SOW52011 / SOW52017 / SOW52014

- ▲ Designed for Traditional / Dangerous Game Hunting and MSR/AR Platforms
- ▲ Extended Long Range Scenarios, as well as Low Light Shooting, and Recreational Shooting Across a Wide Range of Calibers
- ▲ Offered in SFP with Multiple Reticle Options

ELECTRO-OPTICS



Shot on location in the San Juan and Rio Grande National Forests, permission granted under special use authorization.

WHISKEY3™

HUNTING RIFlescOPES

The WHISKEY3 riflescopes feature low dispersion glass, rugged chassis, and capped windage and elevation turrets. It's rugged industrial design provides reliability and protection from the elements.

STANDARD FEATURES

- ▲ 3x Zoom Optical System
- ▲ Stealth ID™: Deflection Armor Surfacing
- ▲ Lensarmor™: Abrasion-Resistant Lens Coating
- ▲ Hellfire® Reticles: Fiber Optics to Vary Intensity of Central Aiming Point
- ▲ Low Dispersion (LD) Glass Provides Industry Leading Optical Clarity
- ▲ European Style Eyepiece for a Smooth, Fast, and Precise Reticle Adjustment
- ▲ Waterproof (IPX-7 rated) and Fog-Proof Performance
- ▲ 3x Optical Zoom, Illuminated, and Non-Illuminated Reticles
- ▲ Offered in Second Focal Plane (SFP) and Multiple Reticles



WHISKEY3 3-9x40

1" MAINTUBE
SOW33202 / SOW33204 / SOW33206

- ▲ Designed for Traditional / Dangerous Game Hunting and MSR/AR Platforms
- ▲ Extended Long Range Scenarios, as well as Low Light Shooting, and Recreational Shooting Across a Wide Range of Calibers
- ▲ Offered in SFP with Multiple Reticle Options

RETICLES

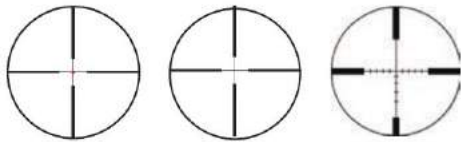

HELLFIRE®
QUADPLEX®

QUADPLEX

BDC-1
QUADPLEX



WHISKEY3 4-12X50

1" MAINTUBE
SOW34201 / SOW34203 / SOW34205

- ▲ Designed for Traditional / Dangerous Game Hunting and MSR/AR Platforms
- ▲ Medium and Long-Range Engagements and Recreational Shooting Across a Wide Range of Calibers and Light Conditions
- ▲ Offered in SFP with Multiple Reticle Options



WHISKEY3 4-12X40

1" MAINTUBE
SOW34202 / SOW34204 / SOW34206

- ▲ Designed for Traditional / Dangerous Game Hunting and MSR/AR Platforms
- ▲ Medium and Long-Range Engagements and Recreational Shooting Across a Wide Range of Calibers and Light Conditions
- ▲ Offered in SFP with Multiple Reticle Options



WHISKEY3 3-9X50

1" MAINTUBE
SOW33201 / SOW33203 / SOW33205

- ▲ Designed for Traditional / Dangerous Game Hunting and MSR/AR Platforms
- ▲ Short, Medium, and Long-Range Engagements and Recreational Shooting Across a Wide Range of Calibers and Light Conditions
- ▲ Offered in SFP with Multiple Reticle Options



WHISKEY3 2-7X32

1" MAINTUBE
SOW32201 / SOW32202

- ▲ Designed for Traditional / Dangerous Game Hunting and MSR/AR Platforms
- ▲ Short, Medium, and Long Range Engagements and Recreational Shooting Across a Wide Range of Calibers and Light Conditions
- ▲ Offered in SFP with Multiple Reticle Options



KILO®

DIGITAL LASER RANGEFINDERS

The KILO family of Digital Laser Rangefinders is engineered for extreme accuracy. KILO products are the most advanced, and yet simple to use, rangefinders on the market today. Updating at 4x per second in HyperScan mode, all KILO rangefinders come with proprietary LightWave™ DSP technology, are lightning fast, and amazingly accurate.



KILO2400ABS™ RANGEFINDER

7X25MM
SOK24701

- ▲ Ranges up to 2 miles with the Revolutionary Lightwave DSP Technology for the Fastest and Longest Distance Rangefinder Engine
- ▲ Advanced Rangefinder Featuring an Embedded Applied Ballistics® Elite Calculator and Bluetooth® for Synchronizing with a Free Applied Ballistics App. Available on Both IOS and Android Platforms
- ▲ Integrated Temperature, Humidity, Pressure, and Compass
- ▲ New Milling Reticule with 2.4 MRAD Inner Diameter and 3 MRAD Outer Diameter Center Aiming Circle. Milling Features are 5 MRAD to the Dots and 10 MRAD to the Lines.
- ▲ Includes a Tripod Adapter, Smartphone Jack WindMETER, Ballistic Nylon Molle Kit Bag, Nylon Carry Pouch, Tactical Pen/Stylus, Lanyard, and 3 Spare Batteries
- ▲ Assembled in U.S.A.

RANGES	Up to 1400 YDS DEER	Up to 1800 YDS TREES	Up to 3400 YDS REFLECTIVE
--------	---------------------------	----------------------------	---------------------------------



KILO2400ABS DISPLAY



Configurable reticle with 3 options: Center Aiming Circle only, Center Aiming Circle and Horizontal Milling Grid, and Center Aiming Circle and Horizontal and Vertical Milling Grid



KILO1600™ RANGEFINDER

6X22MM
SOK1660B

- ▲ Ranges up to 2000 Yards with the Revolutionary Lightwave DSP Technology for the Fastest and Longest Distance Rangefinder Engine
- ▲ Features Line of Sight (LOS) or Angle Modified Range (AMR). Units in Yards or Meters to Tenth Y/M Resolution
- ▲ Transparent OLED Display
- ▲ User-Selectable Target Modes Featuring LAST or BEST for Pinpoint Accuracy
- ▲ Simplified User Interface with RANGE and MODE Buttons Only

RANGES	Up to 1000 YDS DEER	Up to 1200 YDS TREES	Up to 2000 YDS REFLECTIVE
--------	---------------------------	----------------------------	---------------------------------



KILO1000™ RANGEFINDER

5X20MM
SOK10001

- ▲ Ranges up to 1200 Yards with the Revolutionary Lightwave DSP Technology for the Fastest and Longest Distance Rangefinder Engine
- ▲ Features Line of Sight (LOS) or Angle Modified Range (AMR). Units in Yards or Meters to Tenth Y/M Resolution
- ▲ High Transmittance LCD display
- ▲ User-Selectable Target Modes Featuring LAST or BEST for Pinpoint Accuracy
- ▲ Simplified User Interface with RANGE and MODE Buttons Only

RANGES	Up to 800 YDS DEER	Up to 1000 YDS TREES	Up to 1200 YDS REFLECTIVE
--------	--------------------------	----------------------------	---------------------------------



ROME0Zero™

MICRO OPEN REFLEX SIGHT

The fastest, most accurate, ultra-compact micro reflex sight. The ROME0Zero optimized for everyday concealed carry, and pistols with slim slide profiles. The sight features a ruggedized, WeaponsGrade™ textured polymer body and the Spectracoat™ HD Polymer lens system. The ROME0Zero enables rapid target acquisition in an everyday carry package at an iron sight price.



ROME0ZERO

1x24MM
SOR01300 / SOR01600

- ▲ Spectracoat HD Polymer Lens with 10 Times the Impact Resistance over Traditional Glass Lenses
- ▲ WeaponsGrade™ Ultralite Polymer Housing Optimized for use with Polymer Pistols, Concealed-Carry and also Slim Slide Profiles such as Single-Stack 1911s, and Subcompact Firearms.
- ▲ Stippling Pattern on the Housing Matches P365® and P365XL Grip Pattern, for an Integrated Look
- ▲ 8 vivid, User Configurable Daytime Illumination Levels
- ▲ MOTAC™ (Motion Activated Illumination System) that Powers Up when it Senses Motion and Powers Down when it does not
- ▲ Parallax Free
- ▲ Highly Efficient, Point Source LED Emitter for a Crisp Dot that is 8 Times more Efficient than Conventional Red Dots
- ▲ 10 Year Battery Life – Unrivaled in a Micro Reflex Sight
- ▲ Assembled in U.S.A.



Designed for use on
SIG SAUER® P365 Pistols
with Optics Ready Slides

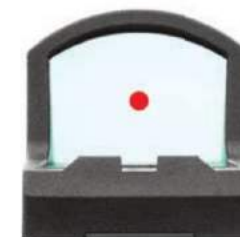

Rear View

RETICLES

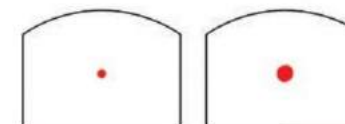

3 MOA

6 MOA

ELECTRO-OPTICS



ROME01™

MINIATURE OPEN REFLEX SIGHT

Designed for fast, responsive target acquisition, and accuracy. The miniature open-reflex ROME01 Red Dot sight was engineered to withstand the punishment of diverse environments.

STANDARD FEATURES

- ▲ Molded Glass Aspheric Lens for Superior Light Transmittance and Zero Distortion
- ▲ Manual Illumination Controls that Remember your Last-Used Settings
- ▲ 3 or 6 MOA Red Dot with Multiple Brightness Settings for Rapid Target Engagement Under a Full Range of Lighting Conditions
- ▲ MOTACT™ (Motion Activated Illumination) Powers up when it Senses Motion and Powers down when it does not
- ▲ Top-loading CR1632 Battery. Allowing for Quick Battery Replacement Without Removal from the Firearm
- ▲ Waterproof (IPX-7 Rated for Complete Immersion up to 1 Meter) and Fog-Proof Performance
- ▲ Designed for Modern Semi-Automatic Pistols, MSR Platforms and Shotguns
- ▲ TruHold™ Lockless Zeroing System that Utilizes Twin Adjustment Springs Designed to Endure Handgun Recoil and Return to Zero Shot after Shot



ROME01PRO™

1x30MM
SORIP100 / SORIP101 / SORIP103

- ▲ Aircraft Grade CNC Aluminum Housing Ensures a Lifetime of Reliable Service
- ▲ Ruggedized Protective Steel Shroud Included for Extreme Durability
- ▲ New Emitter offers a Brighter Dot, More Brightness Settings (10 Daylight and 2NV), and a Longer Battery Life (20,000 hours)
- ▲ Designed to Fit Newer SIG SAUER® R2 Slides

Available in Black



ROME01PRO is Compatible With:

M17, P320-M17, P320 XFIVE LEGION, P320 XCOMPACT, P320 XFULL, All PRO-CUT Slides, P320 Pro Series

Please note, this product is not compatible with slides cut to accept a standard ROME01



ROME01

1x30MM
SOR11000 / SOR11001 / SOR11005 / SOR11600 (6MOA)

- ▲ ROME01 is compatible with legacy optics-ready SIG SAUER® pistols, such as the original P320RX, Classic Line RX, and P320 X-FIVE® pistols. It is not compatible with newer SIG SAUER optics-ready pistols that have the "PRO" slide cut. Those pistols accept the new ROME01PRO.



ROME01 Shroud Kit Also Available. (SOR1SK001)



Adapter Pack Option Available for Glock, CZ-75, Springfield XD, S&W M+P, S&W Core, HK P2000, 1911 Standard, SIG SAUER 1911, P220*, P226*, P227, P229*, P239*, P225*, and P320. Please see sigsauer.com for Additional Options.

SORIMK001 / SORIMK002 / SORIMK003 / SORIMK004 / SORIMK005 / SORIMK006 / SORIMK007 / SORIMK008 / SORIMK009 / SORIMK010 / SORIMK011 / SORIMK012 / SORIMK013 / SORIMK014

RETICLES



3 MOA RED DOT

6 MOA RED DOT

ELECTRO-OPTICS

SIGSAUER

Max Michel



Max Michel
TEAM CAPTAIN

Cabela's
HOGUE
D.O.U.B.L.E.
ALPHA
ACADEMY

ACTION
TARGET

ROME03™

COMPACT OPEN REFLEX SIGHTS

The open reflex ROME03 Red Dot sight is the ideal sighting solution for MSR rifles, shotguns, carbines, submachine guns, and full-size handguns; designed with competitive shooters in mind.

STANDARD FEATURES

- ▲ High Transmittance Red Notch Reflector for Excellent Brightness and Zero Distortion
- ▲ MOTAC™ (Motion Activated Illumination) Powers up or down when Sensing Motion
- ▲ Extremely Strong and Lightweight Aircraft Grade CNC Aluminum Housing Ensures a Lifetime of Reliable Service
- ▲ Side-Loading CR2032 Battery, Allowing for Quick Battery Replacement without Removal from the Firearm
- ▲ Waterproof (IPX-7 Rated for Complete Immersion up to 1 Meter) and Fog-Proof Performance

NEW

ROME03MAX™ COMPACT REFLEX SIGHT

1x30MM
SOR31003 / SOR32003

- ▲ Developed in Collaboration with Team SIG Captain, 8-Time Carry Optics National Champion Max Michel
- ▲ Compact, Open Reflex Sight Featuring a 30mm Wide, Round Lens Design for Superior Field-of-View
- ▲ 3 MOA or 6 MOA Dot with Multiple Intensity Settings for Rapid Target Engagement under a Full Range of Lighting Conditions
- ▲ Comes with a Low-Profile M1913 Picatinny Mount. An Absolute Co-Witness Riser Mount is also Available as an Accessory
- ▲ Red-notch Filter for Vivid Red Dot and Unrivaled Optical Clarity

Used by Max Michel to win the 2019 USPSA Nationals in Carry Optics.



NEW

ROME03XL™ COMPACT REFLEX SIGHT

1x35MM
SOR31004 / SOR32004

- ▲ The Ideal Sighting Solution for MSR Rifles, Shotguns, Carbines, Submachine Guns, and Full-Size Handguns
- ▲ Comes with a Low-Profile M1913 Picatinny Mount. An Absolute Co-Witness Riser Mount is also Available as an Accessory
- ▲ Crisp 3 or 6 MOA Red Dot for Fast and Accurate Shooting
- ▲ Up to 25,000 Hours of Runtime on a Single CR2032 Battery
- ▲ Massive 35mm Wide Lens for Superior Field of View and Fast Target Transition



ROME03 COMPACT REFLEX SIGHT

1x25MM
SOR31002

- ▲ Designed for MSR Rifles, Shotguns, Carbines, Submachine Guns, and Full-Size Handguns
- ▲ Proprietary Red-Notch Coating Ensures Bright Red Dot
- ▲ Manual Illumination Controls

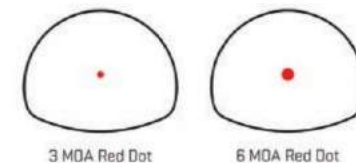



ROME08™

RUGGEDIZED MIL-SPEC RED DOT

Designed for the most severe conditions, the battle hardened ROME08 is ideal for rapid target acquisition in any environment.

STANDARD FEATURES

- ▲ High Performance Coatings for Excellent Light Transmittance and Red Dot Contrast in all Situations
- ▲ Quad Ballistic Circle Dot reticle with ballistic holds and 10 Daytime and NV Settings
- ▲ MOTAC™ (Motion Activated Illumination Systems) Powers Up When it Senses Motion and Powers Down when it does not
- ▲ 1.53" Optical Center Height for Optical Device Compatibility
- ▲ 38mm Rectangular Viewing Window for Unmatched Situational Awareness and Target Identification
- ▲ .5MOA Adjustments for Zeroing, with Ballistic Drops Built into the Reticle for Distance Shooting without Dialing
- ▲ CR123A Battery Provides 100,000 Hours at High-Brightness Setting
- ▲ 1/2" Hex Bolt at 85 in/lb Provides Retention of Zero During Extreme Conditions
- ▲ Assembled in the U.S.A.

ROME08T™ MIL-SPEC RED DOT SIGHT

1X38MM
SOR81002 (BLACK) / SOR81003 (FDE)

- ▲ T10 Torx Screws Attach a Titanium Shroud for Ultimate Optic Protection
- ▲ Removable Titanium Shroud for Ultimate Optic Protection from Hard Use
- ▲ Flip Caps and Anti-Reflective Device Included
- ▲ Dependable IPX-8 Waterproof: Submersible to 20m for 30 Minutes
- ▲ 7075 CNC Aluminum Housing Ensures a Lifetime of Reliable Service

Available
in FDE



ROME08H™ RED DOT SIGHT

1X38MM
SOR81001 (BLACK)

- ▲ Slim Design for Low Profile Footprint
- ▲ Dependable IPX-7 Waterproof: Submersible to 1m for 30 Minutes

RETICLES

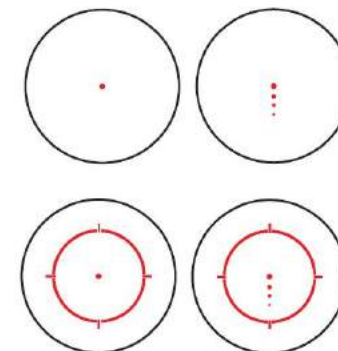

2 MOA Red Dot Ballistic Circle Dot



ROME04T OPTIC HAS BEEN SELECTED BY:
The U.S. ARMY Special Operations
Federal Bureau of Investigations (FBI)
Department of Homeland Security, Customs and Border Protection (CBP)
The U.S. Federal Government Bureau of Prisons

ROME04™

CLOSED RED DOT / GREEN DOT SIGHTS

Chosen by elite government and military agencies, the ROME04 is the ultimate Red Dot sight when fast, accurate target acquisition is a must, regardless of lighting conditions, weather conditions, or terrain. Whether it's a moving target, dangerous game at full charge, or a fast-breaking tactical situation at close quarters, the rugged ROME04 Red Dot sight can handle the job. Battery and solar powered options available.

STANDARD FEATURES

- ▲ Unlimited Eye-Relief to Acquire Aiming Point and Target, Regardless of Eye Position Behind Sight
- ▲ MOTAC™ (Motion Activated Illumination) Powers up When Sensing Motion
- ▲ Utilizes an Ultra-Efficient Red LED Illumination for Daylight Visibility and Extended Runtime
- ▲ Strong and Lightweight Aircraft Grade CNC Aluminum Housing (7075 Grade on ROME04T)
- ▲ Absolute Co-Witness QR Mount and Low Mount Included (Absolute Co-Witness 1/2" Hex Nut on ROME04T)
- ▲ Users can Select from 4 Different Onboard Reticle Options, Per Model (Dot, CircleDot, Dot with Holds, CircleDot with Holds)
- ▲ Assembled in the U.S.A.

ROME04T™ MIL-SPEC RED DOT SIGHT

1X20MM
SOR43031 (BLACK) / SOR43032 (BLACK) / SOR43131 (FDE)

- ▲ Designed for AR Platform Pistols, MSR Platforms, and Shotguns
- ▲ Short and Medium Range Engagements and Recreational Shooting Across a Wide Range of Calibers and Light Conditions
- ▲ MIL-SPEC 810G Tested and Approved
- ▲ Lightweight CNC 7075 Aluminum Housing Ensures a Lifetime of Reliable Service
- ▲ Runtime In Excess Of 100,000 Hours with Solar and Battery Usage
- ▲ Waterproof (IPX-8 rated) and Fog Proof

Available
in Black.



RETICLES

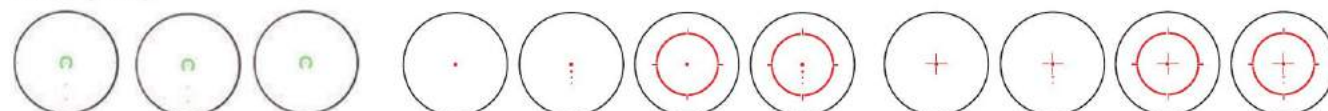

Green Horse Shoe Ballistic Dot (ROME04H Only)

2 MOA Red Dot Ballistic Circle Dot

1 MOA Red Dot Ballistic Circle QUADPLEX™



ROME04DR™ CLOSED RED DOT SIGHT

1x20MM
SOR41111

- ▲ Short and Medium Range Engagements and Recreational Shooting Across a Wide Range of Calibers and Light Conditions
- ▲ Extremely Strong and Light CNC Aluminum Housing
- ▲ Runtime in Excess of 100,000 Hours with Solar and Battery Usage
- ▲ Comes Standard with Lens Caps and Mount
- ▲ Waterproof (IPX-7 rated) and Fog-Proof



ROME04S™ CLOSED RED DOT SIGHT

5x20MM
SOR43021 / SOR43022

- ▲ Short and Medium Range Engagements and Recreational Shooting Across a Wide Range of Calibers and Light Conditions
- ▲ Extremely Strong and Light CNC Aluminum Housing
- ▲ Runtime in Excess of 100,000 Hours with Solar and Battery Usage
- ▲ Comes Standard with Lens Caps and Quick-Release Mount
- ▲ Waterproof (IPX-7 rated) and Fog-Proof



ROME04H™ CLOSED RED DOT SIGHT

5x20MM
SOR43011 / SOR43012 / SOR43013

- ▲ Comes standard with Lens Caps and Quick-Release Mount
- ▲ 50,000+ Hour Battery Life and the Readily Available CR2032 Battery is Side Loading for Quick Battery Replacement
- ▲ Waterproof (IPX-7 rated) and Fog-Proof



ROME05™

CLOSED RED DOT / GREEN DOT SIGHTS

The ROME05 Red Dot Sight mounts on any platform, and even though its small, its tough. The solid, lightweight aluminum design will give peak performance and years of service, making it a trusted companion for the military and civilians alike.

STANDARD FEATURES

- ▲ Ultra-Low Parallax so Point-of-Aim is Point-of-Impact and the Red Dot Remains Parallel to the Bore of Your Firearm, no Matter What Your Viewing Angle is Relative to the Optical Axis of the Sight
- ▲ Unlimited Eye Relief to Acquire Aiming Point and Target, Regardless of Eye Position Behind Sight
- ▲ MOTAC™ (Motion Activated Illumination) Powers Up or Down When Sensing Motion
- ▲ Ultra-Dependable Waterproof (IPX-7 Rated for Complete Water Immersion up to 1 Meter) and Fog-Proof Performance
- ▲ Runs on a Single AAA Battery for up to 50,000 Hours of Runtime Under Normal Use
- ▲ Dual Reticle (5XDR) Quad Reticle (Predator)

ROME05XDR™ CLOSED RED/GREEN DOT SIGHT

1X20MM
SOR52122 (PREDATOR) / SOR52102 (XDR) / SOR521XXXX (FDE)

- ▲ 2 MOA Red Dot with 65 MOA Circle Provides 10 Illumination Settings (8 Daylight Plus 2 NV) for Visibility in all Light Conditions
- ▲ Modular M1913 Picatinny Riser Mount for 1.41" (Absolute Co-Witness) or 1.63" (1/3 Lower Co-Witness) Sight Heights.
- ▲ Dependable Waterproof (IPX-7 Rated for Complete Water Immersion up to 1 Meter) and Fog-Proof Performance
- ▲ Green Predator Reticle Model Available with 4 Green Reticles (Dot, Dot with Triangle, Dot with Lower Triangle, and Triangle only)

Available in FDE (5XDR only)



RETICLES

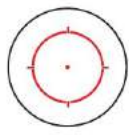

Circle-Dot (65 MOA Circle/ 2 MOA Dot)

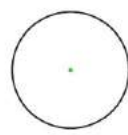

PREDATOR Dot

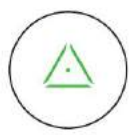

PREDATOR Dot with Triangle

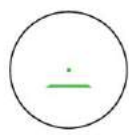

PREDATOR Dot with Lower Triangle



PREDATOR Triangle Only



ROME05X™

1x20MM
SOR52101

- ▲ 2 MOA Red Dot Provides 10 Illumination Settings (8 Daylight Plus 2 NV) for Visibility in all Light Conditions
- ▲ Modular M1913 Picatinny Riser Mount for 1.41" (Absolute Co-Witness) or 1.63" (1/3 Lower Co-Witness) Sight Heights
- ▲ Dependable Waterproof (IPX-7 Rated for Complete Water Immersion up to 1 Meter) and Fog-Proof Performance
- ▲ Runs on a Single AAA Battery for up to 50,000 Hours of Runtime Under Normal use



ROME05 TREAD®

1x20MM
SOR52010

- ▲ 2 MOA Red Dot Provides 10 Illumination Settings (8 Daylight Plus 2 NV) for Visibility in all Light Conditions
- ▲ Integrated M1913 Picatinny Interface Provides Industry-Standard Mounting Options for a Wide Range of Applications
- ▲ Side-loading CR2032 Battery Allowing for Quick Battery Replacement Without Having to Remove the Sight From the Firearm
- ▲ TREAD Logo Laser Engraved



ROME05

1x20MM
SOR52001

- ▲ 2 MOA Red Dot Provides 10 Illumination Settings (8 Daylight Plus 2 NV) for Visibility in all Light Conditions
- ▲ Integrated M1913 Picatinny Interface Provides Industry-Standard Mounting Options for a Wide Range of Applications
- ▲ Side-loading CR2032 Battery Allowing for Quick Battery Replacement Without Having to Remove the Sight From the Firearm



ROME0-MSR™

COMPACT RED DOT SIGHT

The ROME0-MSR is a sealed, compact red dot or green dot sight intended for MSR, carbine, shotgun, and air rifle. Brightness is adjusted with a top-mounted rotary dial, featuring 10 daytime and 2 night vision settings for quick target engagement in any condition.

STANDARD FEATURES

- ▲ Ultra-Compact Size and Weight with Unlimited Eye-Relief and Parallax-Free Operation.
- ▲ Precise 2 MOA Dot
- ▲ Slipover, See-Through Flip-Backs
- ▲ Top Loading Battery Compartment with Integral Brightness Control Featuring 10 Daytime and 2 NV Settings
- ▲ Aircraft Grade Aluminum Housing and Mount
- ▲ Dependable IPX-7 Waterproof and Fog-Proof Performance



ROME0-MSR

1X20MM
SOR72001 (RED) / SOR72002 (GREEN)

- ▲ High-Performance Lens Coatings for Excellent Light Transmission and Dot Contrast in any Situation.
- ▲ 1 MOA Adjustments for Zeroing
- ▲ 1.41" T10 Torx M1913 Skeletonized Lightweight Riser Mount for Absolute Co-Witness
- ▲ Over 20,000 Hours Runtime on a CR1632 Battery



RETICLES

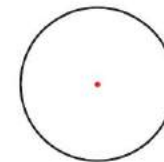

2 MOA Red Dot

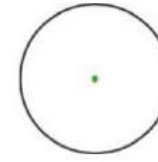

2 MOA Green Dot



ROME07™

CLOSED RED DOT SIGHT

The ROME07 full-size Red Dot sight provides the civilian and armed professional with a robust 1x aiming solution optimized for today's MSR platforms, regardless of caliber.



ROME07™

1x30MM
SOR71001

- ▲ Designed for MSR Platforms for the Civilian and Armed Professional
- ▲ High Performance Lens Coating for Excellent Light Transmission and Zero Distortion
- ▲ Manual Illumination Controls
- ▲ 2 MOA Red Dot is Optimal for Close Quarters Battle to Mid-Range Engagement
- ▲ Side Loading AA Battery Compartment for Ease of Replacement
- ▲ 62,500 Hours of Continuous Battery Life in Medium Setting
- ▲ IPX-7 Rated for Complete Immersion up to 1 Meter

RETICLE

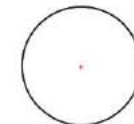



JULIET®

MAGNIFIERS

Easily transition between close quarters and medium range targets with a flip of our JULIET magnifier. When used in conjunction with a Red Dot, the JULIET features a quick-release PowerCam mount which flips easily to one side when not in use. Built-in recoil lugs ensure zero-hold even after removing and reinstalling.

STANDARD FEATURES

- ▲ Quick Release Mount with Built-In Recoil Lugs for a Repeatable Zero
- ▲ PowerCam 90° Mount Pivots to the Side When not Needed
- ▲ Adjustable Height Using Included Spacers
- ▲ Aerospace Grade 6061 Aluminum Housing Ensures a Lifetime of Reliable Service
- ▲ Waterproof Rated IPX-8 (20 Meters for 1 Hour)
- ▲ Assembled in the U.S.A.

POWERCAM 90° MOUNT



JULIET4 Magnifier Pivoted 90° with POWERCAM Mount for Rapid, single-hand use.



JULIET6™ MAGNIFIER

6X24MM
SOJ61001

- ▲ Designed for MSR Platforms and Shotguns
- ▲ Power and Versatility of a 1-6x Scope, in a Modular System That is Lighter Weight
- ▲ Adjustable Base Mount Provides Customization for Red Dot Sight Combination



JULIET3™ MAGNIFIER

3x24MM
SOJ31001

- ▲ Designed for MSR Platforms and Shotguns
- ▲ Power and Versatility of a 1-3x Scope, in a Modular System
- ▲ Adjustable Base Mount Provides Customization for Red Dot Sight Combination



JULIET4™ MAGNIFIER

4x24MM
SOJ41001 / SOJ41002

Available in
FDE

- ▲ Designed for MSR Platforms and Shotguns
- ▲ Power and Versatility of a 1-4x Scope, in a Modular System
- ▲ Adjustable Base Mount Provides Customization for Red Dot Sight Combination

ROMEO® AND JULIET COMBO KITS

JULIET4 AND ROMEO4 COMBO KIT (SORJ43111)
JULIET3 AND ROMEO5™ COMBO KIT (SORJ53101)



ECHO3™

THERMAL REFLEX SIGHT

The most innovative, direct view thermal sight in the world. The ECHO3 uses SIG SAUER® BDX® technology and can record both video and images in 11 different color palettes.

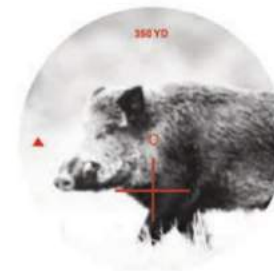

Active Reticle



Custom Fixed Reticle

STANDARD FEATURES

- ▲ Compact Thermal Reflex Style Sight (Don't get Stuck "Behind" a Scope)
- ▲ BDX Enabled WiFi/Bluetooth®, Allowing Active Reticles that Change with KIL0® Rangefinder Input, and Customizable Fixed Reticles that are Configured from the BDX Mobile Application
- ▲ Uncooled 320x240 12um VOx LWIR Core Operating at 30Hz (ITAR Controlled)
- ▲ Levelplex™ Anti-Cant System with Scope Cant Sensitivity down to 0.5°
- ▲ MOTAC™ (Motion Activated Display) Powers up when it Senses Motion
- ▲ Video and Image Recording (including recoil activation) with 11 Color Palettes
- ▲ Greater than 6 Hours of Run Time with Heavy Use
- ▲ Easy to Adjust Lens with Optional Throw Lever Attachment
- ▲ Optional Quick Disconnect Mount
- ▲ Designed and Assembled in the U.S.A. to Withstand IPX-6 Conditions



ECHO3 THERMAL REFLEX SIGHT

1-6X23MM
SOEC31001

- ▲ Aspheric Lens (10° FOV) with up to 6X Digital Magnification
- ▲ Designed for Predator and Hog hunters
- ▲ Improved Situational Awareness



Ballistic Data Xchange



11 Color Palettes, 6 Brightness Settings

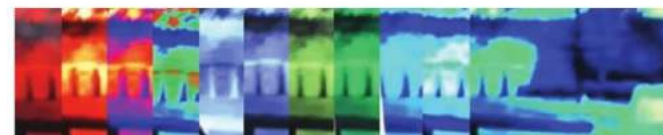



BRAVO[®]

BATTLESIGHTS

The BRAVO battlesights combine crystal-clear fixed-power optics, intuitive reticles, super-bright illumination, and a rugged aluminum housing into one attractive package. Featuring 5.56/.308 and .300 Blackout reticles, this family of optics is the perfect addition for any MSR/AR platform.

STANDARD FEATURES

- ▲ MOTAC™ (Motion Activated Illumination) Powers Up When it Senses Motion and Powers Down when it Does Not
- ▲ Lensarmor™: Abrasion-Resistant Lens Coatings to Withstand the Harshest of Conditions
- ▲ MEGAVIEW Advanced Prism and Ocular Design Yields 40% Greater Field of View Than the Competitive Prism-Based Battle Sights
- ▲ Low dispersion (LD) Glass Provides Industry Leading Optical Clarity
- ▲ Adjustable Eyepiece with +/- 2 Diopter Correction

BRAVO3™ BATTLESIGHT

3X24MM
SOB33101 / SOB33102

- ▲ Designed for Professionals and Civilian MSR/AR Shooters
- ▲ 40% Wider Field of View Than Current Battlesights
- ▲ Distortion Free Image, Edge-to-Edge Clarity
- ▲ Integrated Picatinny Rails for Accessories
- ▲ Waterproof (IPX-7 rated) and Fog-Proof Performance

MEGAVIEW™



Massive 10° Field of View, 40% Wider Than Standard 6° Sights. That's 53 Feet of View at 100 Yards vs. 37 Feet



BRAVO5™ BATTLESIGHT

5x30MM
SOB53101 / SOB53102

- ▲ Designed for Traditional / Dangerous Game Hunting and MSR/AR Platforms
- ▲ Short, Medium, and Long Range Engagements and Recreational Shooting Across a Wide Range of Calibers and Light Conditions



RETICLES

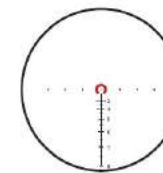

5.56MM / 7.62MM
Horseshoe Dot

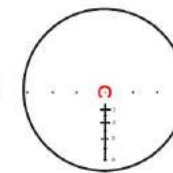

300 Blackout
Horseshoe Dot



ZULU[®]

BINOCULARS

Next to a zeroed rifle, a clear and bright pair of binoculars is the best piece of gear to have on hand. ZULU binoculars perform in the harshest conditions, giving unmatched performance in inclement weather or rugged terrain.

ZULU9[™] HDX[®] ABBE-KOENIG PRISM

9x45 / 11x45 / 15x56
SOZ99001 / SOZ99002 / SOZ99003

- ▲ Combines Superior Optical Performance with In-the-Field Utility
- ▲ High Quality Glass, Fully Multi-Coated Spectracoat[™] Lenses
- ▲ Phase-Coated Abbe-Koenig Prisms Provide Maximum Brightness, Contrast and Crisp Resolution
- ▲ Performs in the Harshest Conditions, Giving Unmatched Performance in Inclement Weather or Rugged Terrain
- ▲ Superior Low Light Performance



ZULU7[™] HDX OPEN-BRIDGE

8x42mm HDX SOZ78001 / 10x42mm HDX SOZ71001 / 12x50mm HDX SOZ71201

- ▲ Multi-Position Twist-Up Eyecups Provide a Custom Fit for Each User
- ▲ Fully Multi-Coated Roof Prism Binocular Incorporates Super High Reflectance Phase-Coated BAK4 Prisms for Unmatched Resolution and Image Contrast
- ▲ Field & Stream Best of the Best Winner 2016



ZULU5[™] HD OPEN-BRIDGE

8x42mm HD SOZ52081 / 10x42mm HD SOZ52101 / 12x50mm HD SOZ52121 / 12x42mm HD SOZ52122

- ▲ HD Glass for Superior Clarity and Color Correctness
- ▲ Silver Deposition Phase-Coated BAK4 Prisms
- ▲ Lightweight and Durable Magnesium Alloy Body



ZULU3[™] COMPACT OPEN-BRIDGE

8x32mm SOZ38001 / 10x32mm SOZ31001

- ▲ Our Low Dispersion Glass Offers Maximized Clarity and Color
- ▲ Uniquely Compact, Can Easily be Held for Extended Periods
- ▲ Rugged Polymer Frame and Non-Slip Rubber Armor



OSCAR®

SPOTTING SCOPES

The OSCAR family of spotting scopes delivers unmatched image clarity and performance when it matters most. The OSCAR3 mini spotting scope puts a powerful optic in the palm of your hand, and features the advanced Optical Image Stabilization (OIS) technology, for improved image quality at the highest magnification, to make spotting your target faster and easier. Ideal for backpacking, hunting, wildlife and sports observation, along with law enforcement and military reconnaissance. The new OSCAR8 angled eyepiece spotting scope is the newest addition to the OSCAR family of spotting scopes from SIG SAUER®. Featuring the industry-leading HDX® optical design, extra-low dispersion glass with high light transmittance glass, and full multi-coated lenses to deliver unmatched resolution, image contrast, and color clarity. When spotting in the field for long periods, the ergonomic design and durable rubber armor of the OSCAR8 delivers unmatched results in all conditions.

NEW

OSCAR8™

27-55X80MM
SOO82001

- ▲ HDX Advanced optical system comprising both High Definition (ED) and High Transmittance (HT) glass for ultra-high resolution, optical performance, and light transmission
- ▲ SCHMIDT-PECHAN prism, combined with HD glass, provide unmatched chromatic and spherical aberration correction for clear, vibrant images
- ▲ Spectracote™ highly efficient, ultra-wide broadband, anti-reflection lens coatings reduce surface reflections to extremely low levels across the entire visible spectrum providing superior light transmission
- ▲ Angled eyepiece, combined with rotating tripod collar, provides the user with multiple viewing angles, to accommodate setup and usage in any terrain
- ▲ Comes equipped with a variable power eyepiece. This eyepiece can be locked into place or removed so that the OSCAR8 can accept other variable or fixed power eyepieces.
- ▲ Waterproof and fog proof, the OSCAR8 will provide unmatched performance in all environmental conditions
- ▲ Adjustable eyecups allow the user to optimize eye relief for use with or without glasses
- ▲ Lightweight and robust aircraft grade aluminum housing, combined with rubberized non-slip grip armor, ensures a lifetime of use in the worst conditions
- ▲ Custom SIG SAUER fitted neoprene cover included
- ▲ Assembled in U.S.A.



OSCAR3™

10-20X30MM
SOV31001

- ▲ Advanced Electronic Image Stabilization Technology that Fits in the Palm of a Hand
- ▲ OIS Optical Image Stabilization Removes Human Motion and Jitter for Improved Image Quality and Target Identification under High Magnification
- ▲ Ideal for Backpacking, Hunting, Wildlife and Sports Observation, Law Enforcement, and Military Reconnaissance
- ▲ The Small Size and Capability of the OSCAR3 is Ideal for Backpacking, Spot/Stalk and Tree Stand Archery, or Long Range Rifle Hunting in Open Country or Mountains as well as Concealed Viewing Situations for LE or Military Use



LIMA[®]

LASER SIGHTS

The most advanced red or green lasers on the market, the proprietary LIMA Laser Grip Module and low-profile LIMA Laser integrate seamlessly with your SIG SAUER[®] pistol.

Standard Features

- ▲ Latest Generation 5 MW Red or Green Lasers for Unmatched Runtime
- ▲ Ambidextrous Laser Activation Supports All Grip Types
- ▲ Windage and Elevation adjustments
- ▲ Powered by Lithium 1/3N Battery
- ▲ Instant Activation Tact Switch
- ▲ Assembled in U.S.A.



new

LIMA1[™]

RED/GREEN PISTOL LASER
SOL11001 / SOL11002

- ▲ Ideal for Target Shooting, Conceal Carry and Personal Defense
- ▲ Designed to fit M1913 and SIG Rails
- ▲ Powered by Lithium 1/3N Battery
- ▲ Instant Activation Left and Right Tact Switches
- ▲ Shown with M17 Pistol, (Not Included)

LIMA320[™]

RED/GREEN LASER GRIP
SOL51001 / SOL51002

- ▲ Integrates and Fits Perfectly with our P320[®] and P250[®] Pistol Platforms
- ▲ State-of-the-Art Laser Targeting in a Package that is Stealth and Virtually Invisible to the Operator
- ▲ Same Material as SIG SAUER Standard Polymer Frames and Textured to Match
- ▲ Seamlessly Integrates Either a Red (Oclaro) or Direct Green (Osram) High Quality and High Efficiency Laser Module for Extreme Accuracy
- ▲ Works with Carry, Compact and Full Size
- ▲ Shown with P320 Slide, Magazine, and Trigger Group, (Not Included)
- ▲ Assembled in the U.S.A.



LIMA38[™]

RED PISTOL LASER
SOL13B01

- ▲ Ideal for Target Shooting, Concealed Carry and Personal Defense
- ▲ Precision Engineered to fit SIG P238 and P938 Pistols, Including Rubber Grip Variants
- ▲ Powered by Lithium 1/3N Battery
- ▲ Dual-sided Switch Supports Ambidextrous Operation
- ▲ Momentary or Continuous Activation with 5 Minute Auto-Timeout
Shown with P238 Pistol, (Not Included)



LIMA365[™]

RED/GREEN PISTOL LASER
SOL36501 / SOL36502

- ▲ Ideal for Target Shooting, Conceal Carry and Personal Defense
- ▲ Designed to perfectly fuse against the SIG P365[®] trigger guard for seamless fit
- ▲ Powered by Lithium 1/3N Battery
- ▲ Instant Activation Tact Switch
- ▲ Shown with P365 Pistol, (Not Included)
- ▲ Assembled in the U.S.A.



FOXTROT®

WEAPON MOUNTED LIGHTS

The FOXTROT series of pistol lights provide bright, crisp, white light and come ready to mount on your SIG SAUER® pistol.



FOXTROT365™

WEAPON MOUNTED LIGHT
SOF36501

- ▲ Up to 100 Lumens and 3 Hour Run Time
- ▲ Ideal for Law Enforcement, Concealed Carry and Personal Defense
- ▲ Designed to Perfectly Fuse with the SIG P365® Trigger Guard for a Seamless Fit
- ▲ Latest Generation Cree LEDs for Maximum Brightness and Runtime
- ▲ Instant Activation Tact Switch
- ▲ Powered by Lithium 1/3N Batteries
- ▲ Shown with P365 Pistol (Not Included)
- ▲ Assembled in the U.S.A.



FOXTROT1™

WEAPON MOUNTED LIGHT
SOF11001

- ▲ White LED Runs for Over Two Hours at 200 Lumens on a CR123 Battery
- ▲ Ideal for Home Defense, Law Enforcement or Military Applications
- ▲ Mounts to Any Picatinny 1913 or SIG SAUER Proprietary Rails
- ▲ Dual, Finger-Actuated Tact Switches Support Ambidextrous Use
- ▲ Latest Generation Cree LEDs for Maximum Brightness and Runtime
- ▲ User-Selectable Output from 100 / 200 / 300 Lumens
- ▲ Momentary or Continuous On with 5 Minute Auto-Timeout
- ▲ Battery Changed Through the LED Bezel with Quarter Turn Lockout
- ▲ Dependable Waterproof (IPX-7 Rated for Complete Water Immersion up to 1 meter) and Fog-Proof Performance

X-RAY®

ENHANCED DAY/NIGHT SIGHTS

The X-RAY family of pistol sights make target acquisition intuitive and fast in any lighting condition. The high contrast front sights paired with the glare reducing rear sights keep your focus on the front sight. The X-RAY1 front sight combines a durable light pipe with a photoluminescent ring providing a bright dot in daylight and a glowing ring that will see you through the dusk transition. The X-RAY3 line uses a 3-dot tritium system for the most demanding low light environments.



X-RAY3™ ENHANCED DAY/NIGHT SIGHTS

PISTOL SIGHTS

SOX10001 (SQUARE) / SOX10002 (ROUND U) / SOX10003 (SQUARE) / SOX10004 (ROUND U)
SOX10005 (SQUARE) / SOX10006 (ROUND U) / SOX10007 (SQUARE) / SOX10008 (ROUND U)
SOX10009 (SUPPRESSOR HEIGHT)

- ▲ With a Half-Life of 12 years, the 3-Dot Tritium System Allows for Fast Target Acquisition in Low-Light Conditions
- ▲ Oversized Chemical Resistant Fluorescent Polymer Front Dot Provides Confidence in all Environments
- ▲ X-RAY3 come in SIG SAUER® sizes of #6 and #8, Square or Round (U) notched rear sight

X-RAY1™ SIGHT SET

PISTOL SIGHTS

SOX11011 (GREEN) / SOX11012 (GREEN) / SOX11013 (GREEN) /
SOX11014 (GREEN) / SOX11015 (RED) / SOX11016 (RED) / SOX11017 (RED) /
SOX11018 (RED)

- ▲ Three Dot Fiber Optic Sights for Fast Target Acquisition
- ▲ Luminescent Front Sight Ring Glows in the Dark for up to 1 Hour
- ▲ Available in Red or Green Light Pipe
- ▲ Round (U) Notch Sight

Standard Features

- ▲ Oversized Chemical-Resistant Fluorescent Polymer Front Dot Sight Gives Confidence in any Environment
- ▲ Torture Tested to 20,000 Rounds, the Steel Housing Provides a Tough, Reliable Sight that Lasts as Long as the Firearm
- ▲ Rear Sights come in Standard SIG SAUER® sizes of #6 and #8
- ▲ Fits SIG SAUER P238®, P938®, P250®, P320® and Classic Line Models



ASSEMBLED IN USA

ALPHA™

RIFLESCOPE MOUNTS/RINGS

Our hard black anodized, precision-machined, ALPHA Tactical Rings are crafted from aircraft grade aluminum. Built with the same unique industrial design as our electro-optics, our rings and mounts not only look tough, but are tough.

Our proprietary steel alloy ALPHA Hunting Rings are machined with an exactness that is both strong and ductile, which allows our rings to form around a riflescope, and will not cause damage with proper installation. The steel rings are epoxy powder coated to prevent oxidation and resist gun oils, cleaning solutions, and outdoor exposure.

NEW

ALPHA3™ SCOPE MOUNT

SCOPE MOUNT

SOA30001 | 30MM 0 CANT
SOA30003 | 30MM 0 MOA
SOA30005 | 34MM 0 CANT
SOA30006 | 30MM 20 MOA CANT
SOA30007 | 34MM 20 MOA CANT

- ▲ Lightweight Cantilever Design Optimized for use on MSR Platforms
- ▲ Precision Machined to Exacting Standards from 7075 Aluminum
- ▲ Titanium Hardware for Superior Performance
- ▲ Available Heights Ranging From 1.375" - 1.535"
- ▲ Available Weights Ranging from 4.6oz - 4.7oz



ASSEMBLED IN U.S.A.



ALPHA2™ TACTICAL

SCOPE MOUNT

SOA20001 | 30MM 0 CANT (BLACK)
SOA20002 | 30MM 20 MOA CANT (BLACK)
SOA20003 | 34MM 0 CANT (BLACK)
SOA20004 | 34MM 20 MOA CANT (BLACK)
SOA20005 | 30MM 20 MOA CANT (FDE)

Available in
FDE

- ▲ Cantilever Design for Use on MSR Platforms
- ▲ 0 or 20 MOA Cant Options
- ▲ 1.53" High
- ▲ Available Weights Ranging from 5.2oz - 5.5oz



ALPHA1™ TACTICAL

SCOPE RINGS

SOA10001 / SOA10002

- ▲ Aluminum 1-Piece Cantilever Design with HELICOILS for Locking Down with Confidence Same Industrial Design as our Electro-Optics
- ▲ 1.5" High
- ▲ Available Weights Ranging from 5.2oz - 5.4oz



ALPHA1 HUNTING

SCOPE RINGS

SOA10001 / SOA10002 / SOA10003 / SOA10004 / SOA10005 / SOA10006 / SOA10007 / SOA10008 / SOA10009 / SOA10010 / SOA10011 / SOA10012 / SOA10013 / SOA10014 / SOA10015 / SOA10016 / SOA10017 / SOA10018 / SOA10019 / SOA10020 / SOA10021 / SOA10022 (MACHINED ALUMINUM)
SOA10003 / SOA10004 / SOA10005 / SOA10006 / SOA10007 / SOA10008 (MACHINED STEEL)

- ▲ Proprietary Weaver Style Rings that are Epoxy Powder-Coated to Prevent Oxidation and Resist Gun Oils, Cleaning Solutions, and Outdoor Exposure, Set of 2
- ▲ Available Heights Ranging From 0.75" - 1.25"
- ▲ Available Weights Ranging from 1.3oz - 6.7oz

ELECTRO-OPTICS

SUPPRESSORS





ELITE PERFORMANCE AMMUNITION
20 *Match Grade* Centre Fire Cartridges

SIG SAUER

ELITE PERFORMANCE AMMUNITION
20 *Match Grade* Centre Fire Cartridges

Made in the USA

WARNING: KEEP OUT OF REACH OF CHILDREN

SUPPRESSOR TECHNOLOGY

WELCOME TO THE FUTURE OF SILENCE.

SIG SAUER engineers have developed the next generation of pistol suppressors. With decades of product design and R&D experience under our belts, suppressors are not treated as bolt-on accessories. At SIG it is understood that suppressors interact with your firearm's system and can affect accuracy, reliability, back-pressure, and other critical factors. We design our suppressors to be part of a completely integrated system to maximize overall performance, and as a result we build the most advanced, most dependable suppressors the world has ever seen, or heard.







PISTOL

SUPPRESSORS

The pistol suppressor line from SIG SAUER features completely modular and configurable titanium baffles for the ultimate in lightweight performance that allows the user to personalize their suppressor for overall length, weight, and sound. The MOD-X9 and MOD-X45 provide class-leading sound performance and can be easily disassembled and reconfigured with fewer baffles when your priority is size over sound. The MOD-X suppressors feature 21 points of impact adjustment and come with a fixed barrel spacer for carbine use. Each MOD-X suppressor includes the most popular inch and metric piston for its given caliber.



MODX-45

45^{AUTO}
MODX-45

- ▲ Segmented Titanium 3D Printed
- ▲ .578X28 and M16X1LH
- ▲ Multi-Caliber Capable with Accessory Pistons



MODX-9

9mm
MODX-9

- ▲ User-Serviceable
- ▲ Titanium Baffles
- ▲ Shooter can Adjust the Number of Baffles to make the Overall Length when Size is More Important than Sound Performance
- ▲ Includes Two Pistons (1/2"x28tpi& M13.5x1LH) and Fixed Barrel Spacer





RIFLE

SUPPRESSORS

The next generation of suppressor technology has arrived. The SLX series of rifle suppressors from SIG SAUER was born out of today's military requirements and is designed to deliver cutting edge performance. The new Clutch-LOK QD mounting system is easy to use, repeatable, and extremely durable. The cross flow baffle design delivers an entirely new shooting experience while reducing harmful toxic gases to the user, allowing gases to expand and cool at a faster rate than the traditional baffle design, while minimizing increase in bolt speed.

new

SLX762TI-QD

7.62^{NATO}
SLX762TI-10

- ▲ 7.62mm
- ▲ 5/8x24 Muzzle Device Included
- ▲ Titanium Construction
- ▲ Cross Flow Design to Reduce Blowback
- ▲ 8.1" L x 1.75" W



new

SLX556-QD

5.56^{NATO}
SLX556-QD

- ▲ 1/2x28 Muzzle Device Included
- ▲ Inconel and Stainless Steel Construction
- ▲ Cross Flow Design to Reduce Blowback
- ▲ 7" L x 1.57" W



new

SLX762-QD

7.62^{NATO}
SLX762-QD

- ▲ 5/8x24 Muzzle Device Included
- ▲ Inconel and Stainless Steel Construction
- ▲ Cross Flow Design to Reduce Blowback
- ▲ 7.4" L x 1.57" W

new

SLX556

5.56^{NATO}
SLX556

- ▲ Direct Thread
- ▲ Inconel and Stainless Steel Construction
- ▲ 1/2x28 TPI
- ▲ Cross Flow Design to Reduce Blowback
- ▲ 7" L x 1.57" W



new

SLX762

7.62^{NATO}
SRD762

- ▲ Direct Thread
- ▲ Inconel and Stainless Steel Construction
- ▲ 5/8x24 TPI
- ▲ Cross Flow Design to Reduce Blowback
- ▲ 7.4" L x 1.57" W



new

SLX762TI

7.62^{NATO}
SLX762TI

- ▲ Direct Thread
- ▲ Titanium Construction
- ▲ 5/8x24 TPI
- ▲ Cross Flow Design to Reduce Blowback
- ▲ 8.1" L x 1.75" W



RIMFIRE

SUPPRESSOR

The SIG SAUER rimfire suppressor features a rugged titanium tube and stainless steel baffles that are fully user-serviceable for increased durability, reliability, and accuracy.



SRD22X

22 LR / 22 MAG
SRD22X

- ▲ User Serviceable
- ▲ Grade 9 Titanium Tube
- ▲ All 17-4 Stainless Baffles
- ▲ Rated from 22 LR to 22 MAG

SIG AIR[®]







SIG AIR®

BY SIG SAUER

From the most elite name in firearms comes the most innovative line of airguns and airsoft guns that combines the unmatched reliability, performance, and exacting standards of SIG SAUER.

The SIG AIR product line includes a series of traditional CO₂ pellet and BB rifles and pistols, that are designed to imitate the look, weight, balance, and handling characteristics of their traditional firearms counterparts. SIG AIR has developed a precision line of break barrel, pre-charged pneumatic (PCP), and single stroke pneumatic rifles and pistols, all meeting the high standards of SIG SAUER firearms.

SIG AIR has expanded to training products with the PROFORCE® line of airsoft pistols, rifles, and accessories. Designed and developed from the ground up to deliver a realistic training experience that allows the user access to achieve a new level of unrealized performance potential. The SIG AIR PROFORCE series of pistols and rifles allows for flexibility in your training environment and is an economical alternative to training with firearms.

A heavy emphasis on consistency was the focus when developing the SIG AIR PROFORCE line. Each PROFORCE model closely matches its real steel complement in model specs and delivers an authentic user experience. The PROFORCE line is also engineered to SIG quality standards using authentic materials and, where necessary, patented performance innovations.

Perfected for muscle memory exercises, shooting drills, and tactical training, these airsoft and airgun models are the economic and authentic answer to training more often, more effectively, and more affordably.

The full line of SIG AIR products delivers a completely authentic SIG handling experience with the firepower you can rely on for all of your hunting, sporting, and practical training needs.

Shoots like a SIG, Because it is One.

•SIG AIR products are recommended for ages 18 plus.

The logo features the word "SIG" in a bold, black, sans-serif font, followed by the word "AIR" in a white, outlined, sans-serif font.



PROFORCE[®] MCX

AUTOMATIC ELECTRIC GUN (AEG)

Modeled after its real steel counterpart, the PROFORCE release of the SIG SAUER MCX VIRTUS[®] Airsoft AEG (Auto Electric Gun) Rifle does not disappoint. With a Full CNC machined receiver, integrated M-LOK[®] handguard, 3-position telescoping stock, open full-length picatinny rail for the addition of sights, and a modular locking accessory mounting system. The MCX Virtus is a polymer airsoft BB slinging brute with 120 round mid-cap magazine that keeps you active and engaged on the firing line.



new

PROFORCE VIRTUS MCX

6mm AIRSOFT BB

AIR-PF-MCX AEG

- ▲ All Metal CNC Machined Receiver and Handguard
- ▲ M-LOK Handguard and Picatinny Rail
- ▲ 3-Position Telescoping Stock
- ▲ 120rd BB Magazine
- ▲ Safe, Semi, Full-Auto Mode
- ▲ Quick Change Tuning Springs (110mm & 120mm included)
- ▲ 11.1v LiPo Battery (not included)
- ▲ Velocity Up to 375 FPS*

*Velocity achieved with .20g BB's and 120 mm tuning spring



PROFORCE® PISTOLS

AIRSOFT PISTOLS

For the first time the SIG SAUER Modular Handgun System (MHS) is available in an airsoft platform for the training professional. The SIG AIR® PROFORCE M17® and M18® has the same look, feel, and action as the official sidearm selected by all branches of the U.S. Military.



new

PROFORCE M18

6mm AIRSOFT BB
AIR-PF-M18GG

- ▲ Optic Ready Slide (AIR-REFLEXSIGHT)
- ▲ Full Blowback Metal Slide
- ▲ Field Strippable with Similar Balance and Weight as Firearm Counterpart
- ▲ Compatible with M17 CO₂ Magazine
- ▲ 21rd BB Magazine
- ▲ Velocity up to Up to 320 fps* Green Gas / 410 fps* CO₂

 GREEN GAS Only

Based on the M18 firearm selected by the U.S. Military

*Velocity achieved with .20g BB's

new

PROFORCE M17

6mm AIRSOFT BB
AIR-PF-M17 / AIR-PF-M17-GG

- ▲ Optic Ready Slide (AIR-REFLEXSIGHT)
- ▲ Full Blowback Metal Slide
- ▲ Field Strippable with Similar Balance and Weight as Firearm Counterpart
- ▲ Compatible with CO₂ and Green Gas Magazine
- ▲ 21rd BB Magazine
- ▲ Velocity up to Up to 320 fps* Green Gas / 410 fps* CO₂



 GREEN GAS version Available

new

PROFORCE P229®

6mm AIRSOFT BB
AIR-PF-229

- ▲ Full Blowback Metal Slide
- ▲ All Metal Slide and Frame
- ▲ Field Strippable with Similar Balance and Weight as Firearm Counterpart
- ▲ Picatinny Rail Mount
- ▲ 23rd BB Magazine
- ▲ Up to 295 fps* Green Gas Only



 GREEN GAS Only

Selected by the U.S. Coast Guard as an official training weapon.

new

SIG AIR
Reflex Sight
Page 180





MCX VIRTUS PCP

SEMI-AUTOMATIC PRE-CHARGED PNEUMATIC RIFLE

The MCX VIRTUS PCP rifle is the latest expansion to the SIG AIR® precision line of airguns, and the introduction of SIG AIR products to the pre-charged pneumatic (PCP) category of airguns. The MCX VIRTUS PCP doubles the muzzle energy of classic CO₂ models and uses the SIG Rapid Pellet Magazine making it ideal for target training and varmint hunting.

NEW



SIG AIR ACCESSORIES
Page 180-181



VIRTUS MCX

.22cal

AIR-VIRTUS-22

- ▲ 3,000 psi, 13 cu.in. Removable Tank
- ▲ 1,100 psi Regulated Output
- ▲ 30rd RPM™ Rapid Pellet Magazine
- ▲ Flip-Up Front and Rear Sights
- ▲ 17.5" Barrel
- ▲ 12FP Muzzle Energy
- ▲ Velocity Up to 700 fps*

*Velocity achieved with 13.7g Pellets



SIG RPM™

RAPID PELLET MAGAZINE

The unparalleled performance of SIG SAUER patented pellet drive system smoothly feeds up to 30 rounds in 3.5 seconds. Rifles come standard with one magazine and refillable belt. Accessory RPM (purchased separately) includes three spare belts.

SIG AIR



ASP20

BREAK BARREL AIR RIFLES

Shoot with less effort and greater accuracy with the SIG AIR® ASP. The most advanced break barrel air rifle to hit the marketplace with consistent barrel lock-up, lower cocking effort, smooth trigger pull, and the premium rifling that can only come from SIG SAUER.



ASP20 WOOD STOCK

.177 / .22 CAL

AIR-ASP20-1711 / AIR-ASP20-2211

AIR-ASP20-1711SC / AIR-ASP20-2211SC (SCOPE OPTIONS)

- ▲ Smooth and Consistent 2-Stage MATCHLITE Trigger
- ▲ Glidelite Cocking Mechanism Ensures Lightest Cocking Effort in this Power Level
- ▲ Custom European Hardwood Stock
- ▲ Optional Scope Combo with WHISKEY3 ASP 4-12x44 scope
- ▲ Single Shot Pellet Rifle
- ▲ Energy: 20 FP in .177 cal / 23 FP in .22 cal
- ▲ Velocity up to 1020 fps* in .177 cal / 840 fps** in .22 cal
- ▲ Built in U.S.A.



ASP20 SYNTHETIC STOCK

.177 / .22cal

AIR-ASP20-1721 / AIR-ASP20-2221

AIR-ASP20-1721SC / AIR-ASP20-2221SC (SCOPE OPTIONS)

- ▲ Smooth and Consistent 2-Stage MATCHLITE™ Trigger
- ▲ Glidelite™ Cocking Mechanism Ensures Lightest Cocking Effort in this Power Level
- ▲ Synthetic Stock with QD Mounts for Sling Usage
- ▲ Optional Scope Combo with WHISKEY3™ ASP 4-12x44 scope
- ▲ Single Shot Pellet Rifle
- ▲ Energy: 20 FP in .177 cal / 23 FP in .22 cal
- ▲ Velocity up to 1020 fps* in .177 cal / 840 fps** in .22 cal
- ▲ Built in U.S.A.



SIG AIR
DAGGER / ZERO
Lead Pellets Page 181

*Velocity achieved with 8.64gr lead pellet
**Velocity achieved with 14.65gr lead pellet



SUPER TARGET

SINGLE STROKE PNEUMATIC PISTOL

A match-grade, single-shot pneumatic air pistol that features a 7.5 inch rifled barrel for exceptional accuracy and a fully-adjustable two-stage trigger. The SIG AIR® Super Target lives up to its name delivering match-grade performance with every shot.



SUPER TARGET

.177 CAL PELLETS
AIR-ST-177

- ▲ Single-Stroke Pneumatic
- ▲ Entry Level 10 Meter Target Pistol
- ▲ Two-Stage Adjustable Trigger
- ▲ Custom Wood Grips
- ▲ Single Shot Precision Pistol
- ▲ Up to 350 fps*



SIG AIR
VENOM Lead Pellets
Page 181

* Using 7.71 match lead pellet



AIR MCX RIFLE

SEMI-AUTOMATIC CO₂ AIR POWERED

Just like the SIG SAUER MCX redefined the modern pistol caliber carbine, the SIG AIR® line of MCX rifles redefines the CO₂ category of air rifles by delivering authentic SIG performance, handling, and rapid-fire capability.

AIR MCX SCOPE

.177 CAL PELLETT

AIR-MCX-SCOPE-177-88G-30-BLK
AIR-MCX-SCOPE-177-88G-30-FDE

- ▲ Metal Housing with Polymer Handguard and Stock
- ▲ 30rd RPM Pellet Magazine
- ▲ 1-4 x 24 Scope
- ▲ Picatinny Rail
- ▲ Vertical Foregrip
- ▲ 90g CO₂ Power Source (sold separately)
- ▲ 18" Rifled Barrel
- ▲ Velocity Up to 700 fps*

Available in
Black



AIR MCX

.177 CAL PELLETT

AIR-MCX-177-88G-30-BLK / AIR-MCX-177-88G-30-FDE
AIR-MCX-MRD-177-88G-30-BLK / AIR-MCX-MRD-177-88G-30-FDE

Available in
FDE

- ▲ Metal Housing with Polymer Handguard and Stock
- ▲ 30rd RPM Pellet Magazine
- ▲ Flip up Front and Rear Sights
- ▲ Picatinny Rail
- ▲ Vertical Foregrip
- ▲ 90g CO₂ Power Source (sold separately)
- ▲ 18" Rifled Barrel
- ▲ Available with Red Dot Sight
- ▲ Velocity Up to 700 fps*



Available with
Red Dot Sight

SIG AIR



SIG RPM™

RAPID PELLETT MAGAZINE

The unparalleled performance of SIG SAUER patented pellet drive system smoothly feeds up to 30 rounds in 3.5 seconds. Rifles come standard with one magazine and refillable belt. Accessory RPM (purchased separately) includes three spare belts.

* Results may vary based on ammo weight, temperature, and altitude.



AIR MPX RIFLE

SEMI-AUTOMATIC CO₂ AIR POWERED

Just like the SIG SAUER MPX redefined the modern pistol caliber carbine, the SIG AIR® line of AIR MPX rifle redefines the CO₂ category of air rifles by delivering authentic SIG performance, handling, and rapid-fire capability.



AIR MPX MRD

.177 CAL PELLETT

AIR-MPX-MRD-177-BBG-30-FDE /
AIR-MPX-MRD-177-BBG-30-BLK

- ▲ Metal Housing with Polymer Handguard, and Stock
- ▲ 30rd RPM Pellet magazine
- ▲ Includes a 20mm 20R Micro Red Dot Optic
- ▲ Flip up Front and Rear Sights
- ▲ Picatinny Rail
- ▲ Tactical Handstop
- ▲ 90g CO₂ Power Source (sold separately)
- ▲ 8" Rifled Barrel
- ▲ Velocity Up to 575 fps*



Available in
Black.

* Results may vary based on ammo weight, temperature, and altitude.



AIR MPX

.177 CAL PELLETT

AIR-MPX-177-BBG-30-BLK / AIR-MPX-177-BBG-30-FDE

- ▲ Metal Housing with Polymer Handguard, and Stock
- ▲ 30rd RPM Pellet Magazine
- ▲ Flip up Front and Rear Sights
- ▲ Picatinny Rail
- ▲ Tactical Handstop
- ▲ 90g CO₂ Power Source (sold separately)
- ▲ 8" Rifled Barrel
- ▲ Velocity Up to 575 fps*



Available in
FDE



SIG RPM™

RAPID PELLETT MAGAZINE

The unparalleled performance of SIG SAUER patented pellet drive system smoothly feeds up to 30 rounds in 3.5 seconds. Rifles come standard with one magazine and refillable belt. Accessory RPM (purchased separately) includes three spare belts.



AIR PISTOLS

SEMI-AUTOMATIC CO₂ AIR POWERED

SIG AIR® Pistols are inspired by SIG SAUER centerfire pistols and designed with metal slides, rifled steel barrels, and the built-in performance advantages that are synonymous with SIG. With a SIG AIR Pistol you have the ability to train anywhere, anytime.



AIR M17®

.177 CAL PELLETT

AIR-M17-177

- ▲ Based on the M17 Firearm Selected by the U.S. Military
- ▲ Optic Ready Slide (AIR-REFLEXSIGHT)
- ▲ Full Blowback Metal Slide and Polymer Frame
- ▲ Ambidextrous Manual Safety
- ▲ 20rd RPM Pellet Magazine
- ▲ Cam Lever CO₂ magazine system
- ▲ Velocity up to 430 fps*

Based on the M17 firearm selected by the U.S. Military * Results may vary based on ammo weight, temperature, and altitude.

AIR P320®

.177 CAL PELLETT

AIR-P320-177-30R-CYT / AIR-P320-177-30R-BLK

- ▲ Full Blowback Metal Slide and Polymer Frame
- ▲ 30rd RPM Pellet Magazine
- ▲ Picatinny Accessory Rail
- ▲ Manual Safety
- ▲ 12g CO₂ Power Source
- ▲ Velocity up to 430 fps*



AIR P226®

.177 CAL PELLETT

AIR-226F-177-12G-16-BLK / AIR-226F-177-12G-16-FDE

- ▲ Full Metal Blowback Pistol
- ▲ Cam Lever CO₂ Loading
- ▲ Picatinny Accessory Rail
- ▲ 16rd Dual Rotary Magazine
- ▲ Up to 480 fps*



AIR X-FIVE®

.177 CAL PELLETT

AIR-X5-177-BLK

- ▲ Full Metal Blowback Pistol
- ▲ 20rd RPM Pellet Magazine
- ▲ Adjustable Rear Sight
- ▲ Cam Lever CO₂ System
- ▲ Up to 430 fps*



SIG AIR
Reflex Sight
Page 180





BB PISTOLS

SEMI-AUTOMATIC CO₂ POWERED

The SIG AIR® BB pistols feature a full array of the most desired SIG SAUER centerfire pistols in a 4.5mm BB platform for the ability to train anywhere, anytime.



P365 BB

4.5 MM STEEL BB

AIR-P365-BB

- ▲ Blowback Metal Slide and Polymer Frame
- ▲ 12rd Magazine w/Integrated 12g CO₂ system
- ▲ Ambidextrous Manual Safety
- ▲ Green High Visibility 3-dot Fixed Sights
- ▲ SIG Accessory Rail
- ▲ 3.5" Smooth Bore Barrel
- ▲ Velocity up to 295 fps*

1911 SPARTAN BB

4.5 mm Steel BB

AIR-1911BB-SPARTAN

- ▲ Full Metal Blowback Pistol
- ▲ "MOLON LABE" on Oil-Rubbed Bronze slide
- ▲ Custom Spartan Grips
- ▲ Skeletonized Trigger
- ▲ 16rd Magazine
- ▲ 12g CO₂ System
- ▲ Manual Safety
- ▲ 5" Smooth Bore Barrel
- ▲ Velocity up to 410 fps*



1911 WE THE PEOPLE BB

4.5 mm Steel BB

AIR-1911WTP-BB

- ▲ Full Metal Blowback Pistol
- ▲ "We The People" on Slide
- ▲ Distressed Finish
- ▲ 17rd Magazine w/Integrated 12g CO₂ system
- ▲ Ambidextrous Manual Safety
- ▲ 5" Smooth Bore Barrel
- ▲ Velocity up to 410 fps*



* Results may vary based on ammo weight, temperature, and altitude.

SIG AIR® ACCESSORIES

ENGINEERED TO A NEW STANDARD OF PERFORMANCE

SPEC1

PREMIUM AIRGUN AND AIRSOFT ESSENTIALS
SIG AIR is pleased to introduce SPEC1 non-toxic, nonhazardous, pure synthetic-based lubricants to keep your airgun and airsoft products protected and running smoothly. Free from Teflon, silicone and petroleum, SPEC1 lubricants contain an anti-wear agent that reduces friction and wear by 95-98%. They will not harden or become sticky or tacky and do not freeze or gum up when used with CO2. Excellent at displacing moisture, they will not attract dust, dirt, or sand. SPEC1 cleans, lubricates, and protects.

REFLEX SIGHT

Designed for fast, responsive target acquisition with the M17/M18 PROFORCE® and M17 pellet pistol with a 23mm field of view. Mounting plates included to quickly and easily upgrade your SIG AIR pistol.



SIG AIR
Reflex Sight

HAND PUMP

The SIG AIR High-Pressure Hand Pump provides an affordable, reliable, and inexpensive method for filling your PCP airguns. For use with the 13 cu.in tank on the SIG Virtus PCP rifle, but made to work with any brand of PCP gun with a male Foster quick-disconnect fitting. The 3-stage pump goes up to 4500 psi and includes an integral air pressure gauge.



SHOOTING TARGETS

Whether you are training in your garage, basement, or back yard, there is a SIG AIR Target to suit your training needs.



PELLETS

PRECISION MEETS PERFORMANCE

SIG AIR® lead pellets offer a variety of shapes for all uses and differing levels of shooters. Options for shooting paper targets, or metal field targets and silhouettes, SIG AIR pellets will fit the needs and performance required for every shooter.



AIR CYLINDERS

PREMIUM AIRGUN PERFORMANCE

Available high quality, CO₂ cylinders and PCP air tank provide solid platforms for consistency and reliability. The use of SIG premium air cylinders for your SIG AIR products will ensure long lasting SIG performance.



MAGAZINES

ELEVATE YOUR FIREPOWER

Utilizing a variety of different style magazines with innovative features, such as cam lever loading and the patented Rapid Pellet Magazine (RPM), SIG AIR magazines are engineered to elevate performance and firepower in all of your SIG AIR products.



SIG SAUER ACADEMY





SIG SAUER ACADEMY

TRAIN WITH THE PROFESSIONALS



Learn more at sigsaueracademy.com

SIG SAUER
ACADEMY



WE'LL MAKE YOU A BETTER SHOOTER. GUARANTEED

With a team of world class instructors, from a broad range of backgrounds, the SIG SAUER Academy provides the finest firearms and tactics training available today. Using our objective and performance-based training methods we can help develop and expand the abilities of virtually any level of firearms user.

Our expert staff of instructors have the unique ability and experience that allows them to train all types of firearms users, from beginners to experts, from civilians to elite military, and law enforcement agencies. The SIG SAUER Academy is committed to delivering the best, most realistic, fundamentally sound training experience possible. We'll make you a better shooter. Guaranteed.

For course descriptions, schedules, and more, visit sigsaueracademy.com

FACILITIES

The SIG SAUER AcademySM offers 140 acres of state-of-the-art indoor and outdoor training facilities. We have developed a variety of ranges and infrastructure allowing us to create almost any type of environment and to prepare for practically any situation. Facilities include:

- 26 Different Live Fire Ranges
- 270 Degree Range
- 1,000 Yard Rifle Range
- Tactical Training with Breaching Capabilities
- 2 Live Fire Shoothouses
- Obstacle Course
- Indoor Pistol and Rifle Ranges
- Vehicle Defense Range

Additionally, the SIG SAUER Academy is home to the **factory-direct SIG SAUER Pro Shop**, displaying the entire line of SIG SAUER pistols, rifles, electro-optics, suppressors, ammunition, air guns, accessories, and apparel.

PRIVATE AND MOBILE TRAINING

The SIG SAUER Academy is dedicated to providing the highest level of training available, tailored to fit any individual or organized group needs. We provide customized private classes at our Academy, or we can take our expert training to a private location upon request.

Private classes for corporate and executive clients, as well as government agencies and private groups, or individuals, are available either as a standard course listed on our website or as a custom class designed to your specific needs. Private instruction ranges from foundational shooting tutorials to advanced dynamic tactics in a one-on-one or group learning environment.

INTERNATIONAL CUSTOMERS

The SIG SAUER Academy has a diverse staff of expert, bilingual instructors that provide the highest level of training and instruction to international civilian and military/law enforcement customers.

SIG SAUER Academy staff have consistently trained with some of the world's most elite counterterrorism units, providing expert instruction across a wide range of training needs. Our staff and facilities can provide any level of instruction needed to international clients, and can provide all of the necessary equipment and materials, including all tactical equipment and firearms no matter what manufacturer or platform is required.



ABOUT OUR COURSES

PISTOL/RIFLE/SHOTGUN/PRECISION SCOPED RIFLE

The SIG SAUER Academy has programs that are designed to achieve results across a broad range of platforms, from pistols and rifles, to shotguns and precision long-range shooting. All courses are taught from a foundational level and have a progression structure allowing students to develop their skills at their own pace. Depending on your personal training objectives, we offer classes for personal and home defense, individual skill building, and instructor certification.

ADVANCED TRAINING

Advanced training courses are designed to take a student's skills to an extremely high level. These classes help provide students the knowledge, skills, and confidence to improve their performance and decision-making in a high-risk, high-stress environment. These courses include specific subjects such as low light pistol and rifle, advanced medical training, executive protection, as well as vehicle and scenario-based training.

ARMORER

SIG SAUER is one of the many major manufacturers that offers civilian armorer's courses. Our armorer's certification gives students a complete and thorough understanding of SIG SAUER firearms, proper maintenance techniques, and inspection processes. These courses are designed to provide all of the necessary information to preserve the firearms factory warranty. Students who successfully complete these courses receive a three year armorer certification.

LAW ENFORCEMENT/MILITARY

SIG SAUER Academy is dedicated to providing the highest level of global training for military and law enforcement professionals. Courses include specific subjects such as bus and vehicle assault, night vision, breaching, and direct threat care. Any course can be conducted remotely or customized to meet agency or department needs. Custom course design and implementation allow for any desired capability and duration of training. The SIG SAUER Academy also has physical fitness facilities available to visiting groups at no charge.



SIG SAUER
ACADEMY

MORE THAN TRAINING. A DESTINATION.

SIG SAUER ACADEMYSM is located in the Seacoast region of New Hampshire, just an hour north of Boston, and an hour south of Portland, Maine. New Hampshire is home to 18 miles of New England coastline and beaches, and is situated approximately an hour away from several top-rated ski resorts in the White Mountains. Nearby historic Portsmouth is a favorite tourist destination, featuring nationally-recognized restaurants and cuisine, outdoor sight-seeing activities, local boutiques, tax-free shopping, and a thriving nightlife. There are several major transportation hubs allowing easy access along with a wide variety of accommodations available nearby.

PRO SHOP

The SIG SAUER Academy Pro Shop is a full-service, factory-direct retail store open to the public, located on the grounds of the SIG SAUER Academy. The Pro Shop features the entire line of SIG SAUER pistols, rifles, electro-optics, suppressors, ammunition, airguns, accessories, and apparel and also has armorers services available on-site. The Pro Shop staff are highly trained and can provide expert advice on all of the latest SIG SAUER products.



ACCOMODATIONS

Through partnership with SIG SAUER®, we offer special rate arrangements with local hotels in Exeter, Dover, and Portsmouth NH, all within 10-30 minutes of the Academy.

TRANSPORTATION

The SIG SAUER Academy is about 30 minutes east of Manchester, New Hampshire Airport (MHT), and about an hour north of Boston International Airport (BOS) in Massachusetts. Some SIG SAUER partner hotels also offer students free shuttle access to and from the Academy.

EXETER

Boasting tree-lined streets and a wealth of historical architecture, Exeter is a quick 10 minutes from the Academy and hosts three of our preferred hotels. With ample restaurants, shopping and night life, this picturesque river town is a convenient place to stay while training at the Academy and is roughly 10 miles inland from the coast.

PORTSMOUTH

Venture into downtown Portsmouth, where you'll find a steady mix of modern and historic flair. From cobblestone-lined streets and historic buildings, to waterfront dining and local breweries, Portsmouth is not to be missed while here.

TEAM SIG



A TEAM OF THE HIGHEST CALIBER, COMMITTED TO EXCELLENCE

The mission of Team SIG is to support the development and production of the SIG SAUER® P320® pistol platform, the complete SIG SAUER rifle product line, SIG SAUER Electro-Optics, and SIG SAUER Ammunition. Team SIG works closely with the SIG SAUER engineers throughout the development and design of all SIG SAUER products to ensure every shooter enjoys the features that the Team SIG professional shooters demand.

ABOUT OUR SHOOTERS



MAX MICHEL - TEAM CAPTAIN

Max Michel, Jr. is one of the most dominant shooters in the world today and is recognized as a top-tier athlete and instructor. Max is a Guinness World Record holder and International Practical Shooting Confederation World Champion. He holds 8 World Speed Shooting Championships, 12 USPSA National Championships, 5 US Steel National Championships, is a 4-time Carry Optics National Champion, and holds more than 200 additional major championship victories. As an international competitor Max has represented the U.S.A. in the last seven IPSC World Shoots and returned home bearing gold each time and is set to compete once again in 2020 for Team U.S.A..

For Team SIG Max focuses primarily on carry optics competition, and as Team SIG Captain he serves as a mentor for Team SIG and is a premier brand ambassador for SIG SAUER®. Max is a U.S. Army Veteran.

Pistol: P320[®] XFIVE[™]
Optic: ROMEO1[™] or ROMEO3MAX[™]
Ammo: Match Elite (9mm)



LENA MICULEK - PRO SHOOTER

Regarded as the top female 3-Gun competitor in the world, Lena dominates both 3-Gun and PCC competition. Lena entered into the competitive shooting world in 2005 with five consecutive Sportsman's Team Challenge Sub-junior and Junior Division national titles, and at 17 years old she won her first World Champion title. Since turning pro, Lena has earned more than 75 major wins including back-to-back NRA World Shoot "High Lady" titles, a "High Lady" title for carry optics, and 8 world titles. Additionally, in pistol caliber carbine (PCC) competition Lena is breaking barriers for female professional shooters. She is a two-time national female champion for PCC and was the first female to earn a top-five finish in PCC and was the first female to win Master Class for PCC.

For Team SIG Lena competes primarily in pistol caliber carbine (PCC) and 3-Gun competition.

Pistol: P320 XFIVE
Rifle: SIG MPX[®] PCC
Optic: ROMEO3[™] and TANGO6T[™]
Ammo: Match Elite (9mm), Match (.223), Varmint (.223)



DANIEL HORNER - PRO SHOOTER

Daniel Horner is a multi-discipline World Champion shooter having captured over 125 championship titles at the world, national, regional, and state level. His titles include: 2019 All Army Champion, 10 USPSA Multi-Gun National Championships, 4 3-Gun National Championships, 2 International Sniper Competitions, 2 IDPA National Championships, an IPSC Shotgun National Championship, an NRA World Shooting Championship, and many more. Daniel is a U.S. Army Veteran and was recruited to the Army to join the U.S. Army Marksmanship Unit (USAMU), where he became one of the most decorated shooters in team history. He served as the Coach of the USAMU Action Shooting Team, and during his service was twice selected as the Military Marksmanship Association Soldier of the Year.

For Team SIG Daniel competes primarily in 3-gun and long-range rifle competition.

Pistol: P320 XFIVE with iron sights
Rifle: SIGM400[®]
Optic: TANGO6T[™]
Ammo: Match Elite (9mm), Match (.223), Varmint (.223)

PISTOL ACCESSORIES

NEW

P320® PRO CUT SLIDES

Factory replacement PRO-CUT slide assembly for the P320 9mm.

- ▲ Optic Ready with Sight Cover Plate (ROME01PRO™ and DeltaPoint® Pro Footprint)
- ▲ XRAY3™ Night Sights
- ▲ Stylized Relief Cuts
- ▲ Available in Black, Coyote, and Stainless Finishes



P320 X-CHANGE KITS

The modular pistol has arrived. Removing P320 fire control group unlocks hundreds of combinations.

- ▲ Includes: Complete Slide, Barrel, Recoil Spring Assembly, Grip Module, and Magazine
- ▲ Reflex Optic Compatible
- ▲ Not Available for Manual Safety



P320 GRIP MODULES

Engineered to fit your hand and your P320.

- ▲ Full-Size, Carry, Compact, and Sub-Compact
- ▲ XFIVE; XFull, XCarry, XCompact
- ▲ Black, M17 Coyote, and White
- ▲ Large, Medium, and Small (Not Available in All Colors and XSERIES)
- ▲ XFIVE Grip Module Includes Weight and Magazine Funnel



NEW

P320 TXG™ GRIP MODULE

The weight of steel and the flex of polymer

- ▲ Requires Complete P320 Fire Control Unit and XFIVE or Full-Size Slide Assembly
- ▲ Overall Weight is 16.6oz
- ▲ Tungsten-Infused Polymer
- ▲ Available with Extended Magwell and Internal Weight
- ▲ Patent Pending Technology



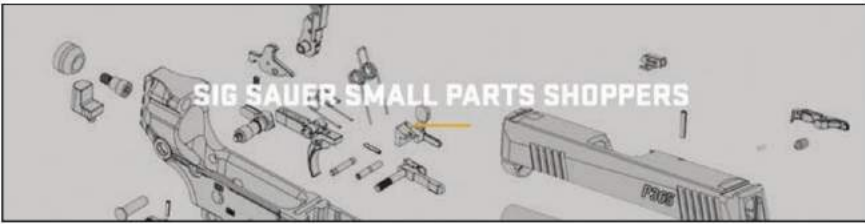

SIG SAUER SMALL PARTS SHOPPERS

Now you can purchase small parts for select SIG SAUER Firearms quickly and easily online at the SIG SAUER Webstore.

The SIG SAUER Small Parts Shopper is exclusive to sigsauer.com and intuitively navigates for upper or lower components of select SIG SAUER firearms so you can get the parts you need.



P320® STIPPLED GRIP

These grips put the "tac" in tactical. Hand stippled by craftsmen in the U.S.A. for those that want more gripping power.

- ▲ Carry-Size XSERIES Grip
- ▲ Black Finish
- ▲ Compatible with Grip Weights and Magazine Funnels



PISTOL MAGAZINES

Original factory magazines designed specifically for SIG SAUER® pistols.

- ▲ Capacities from 6 to 21 Rounds
- ▲ .380 ACP, 9mm, .357 SIG, .40 S&W, 10mm, and .45 ACP



P365 15rd Magazine

PISTOL BARRELS

SIG SAUER factory made pistol barrels.

- ▲ Offered in P238, P938, P210, P220, P226, P229, 1911, P320, and P365 Firearms Families
- ▲ Threaded and Non-Threaded Versions



PISTOL TRIGGER UPGRADES

Introduce the next level in precision to Classic and P320 pistols.

- ▲ Made in Flat and Curved Trigger Configurations



PISTOL PART KITS

Keep your favorite firearm running like new.

- ▲ Replacement Parts Kits for Classic, P320, and P365 Models
- ▲ Factory Approved Parts for Every Need



RIFLE ACCESSORIES

SIG MCX® AR UPGRADE KIT

Transform any MIL-SPEC AR lower receiver into the adaptive and modular SIG MCX® VIRTUS.

- ▲ Complete SIG MCX Upper Receiver Assembly
- ▲ Lower Receiver Stock Adapter
- ▲ Side-Folding AR Buffer Tube Knuckle
- ▲ Two-Stage Match Duo Trigger



SIG MCX RATTLER CONVERSION KIT

Convert any MIL-SPEC AR Lower into a MCX Rattler

- ▲ Complete SIG MCX Rattler Upper Receiver Assembly
- ▲ Lower Receiver Stock Adapter
- ▲ Side-Folding AR Buffer Tube Knuckle
- ▲ Two-Stage Match Duo Trigger

SIG MCX & SIG MPX® STOCKS

Options as diverse as your mission.

- ▲ M4 Adjustable Folding
- ▲ Dual-Rod Collapsible
- ▲ Skeletonized Mini
- ▲ Skeletonized Plus (not pictured)
- ▲ Pivoting Contour Brace
- ▲ Tele-Stock (not pictured)



SIG MCX VIRTUS® HANDGUARDS

Change the barrel and modify the VIRTUS handguard to match.

- ▲ PDW, Carbine, Rifle, and DMR Lengths Available
- ▲ Offered in Black, FDE, and Virtus Gray
- ▲ Suppressor Adaptable Configurations



SIG MCX VIRTUS/RATTLER CALIBER EXCHANGE KIT

Move swiftly and easily between calibers and barrel lengths.

- ▲ 16" Barrels (5.56 NATO/.300 BLK)
- ▲ 11.5" Barrel (5.56 NATO)
- ▲ 9" Barrels (.300 BLK)
- ▲ 6.75" Barrels (.300 BLK)
- ▲ Rattler Only 5.5" (.300 BLK / 5.56 NATO)



SIG MATCHLITE™ TRIGGER

A trigger made for a SIG SAUER rifle, and perfect for any AR.

- ▲ Match Grade Performance
- ▲ Non-Adjustable
- ▲ Includes Hammer and Trigger Pins



SIG MPX® CALIBER EXCHANGE KIT

Transition between barrel lengths efficiently.

- ▲ 16", 8", 6.5", and 4.5" Barrels (9mm)
- ▲ Available for Gen2 MPX Only



SIG MPX HANDGUARDS

Configure the MPX for the barrel and the activity of your choice.

- ▲ K, PDW, and Carbine Lengths Available
- ▲ Offered in Black Anodized



The TREAD® rifle is easily customizable with a full line of purpose-built accessories, designed in the U.S.A. Some items will fit most AR rifles.

TREAD SINGLE STAGE FLAT TRIGGER

Factory Upgrade Single Stage Trigger Kit for TREAD

- ▲ Flat Blade Profile
- ▲ Crisp Break



TREAD ROME05™ 1X20 MM

Robust, Compact Red Dot Sight

- ▲ 1x20 Aiming Solution for TREAD
- ▲ 2 MOA Red-Dot
- ▲ 10 Illumination Settings
- ▲ TREAD Logo



TREAD 3-CHAMBER COMPENSATOR

- ▲ Reduce Recoil and Muzzle Rise
- ▲ 5.56 mm, 1/2 x 28



TREAD AMBI CHARGING HANDLE

- ▲ Full Ambidextrous Design
- ▲ Medium-Sized Latches and Dual Roll Pin
- ▲ Aircraft Grade Aluminum



TREAD M-LOK® HANDGUARDS

- ▲ Available in 10", 13", and 15" Lengths
- ▲ M-LOK Free Float Aluminum
- ▲ Two Screw Replacement



TREAD FLIP UP SIGHTS

Factory Replacement Sights Set for TREAD

- ▲ Tool-Less Adjustment
- ▲ Button-Less Flip-Up and Lock
- ▲ Includes Sight Rail



TREAD VERTICAL GRIP KIT

- ▲ M-LOK Compatible
- ▲ Dual Angle Vert Grip
- ▲ Includes Barricade Stop



TREAD M-LOK FORWARD GRIP KIT

- ▲ Vertical Grip, Barricade Stop, Handstop, Long and Short Rail Sections
- ▲ M-LOK Compatible



*Visit sigsauer.com for additional items

SPEC1

COMPLETE PREMIUM CARE SYSTEM

SIG SAUER is pleased to introduce SPEC1, a premium firearm cleaning system. SPEC1 is a non-toxic, non-hazardous, pure synthetic-based lubricant with no Teflon™, silicones, or petroleum distillates. SPEC1 is formulated to reduce heat and wear, and to keep firearms running smoother and lasting longer. SPEC1 will not attract dust, dirt and sand, or feel sticky and tacky like most petroleum-based products on the market today. This synthetic lubricant will not dry up, freeze in cold temperatures, or allow carbon, copper, and plastic wad fouling to stick in the barrels or to gun parts. This non-toxic, non-hazardous formula is completely safe for the end user during application, cleaning, and firing.

SPEC1 PREMIUM BLEND

- ▲ Pure Synthetic Based Lubricant with no Teflon™, Silicones, or Petroleum Distillates
- ▲ Available in a 2oz and 4oz Bottles



SPEC1 PREMIUM BLEND 30 HEAVY DUTY

- ▲ Pure Synthetic Based Lubricant with no Teflon™, Silicones, or petroleum distillates
- ▲ Available in a 2oz and 4oz Bottles
- ▲ 30 WT Equivalent



SPEC1 PREMIUM CLEANING SYSTEM

- ▲ Premium Bore Solvent that Removes Carbon, Lead, and Plastic
- ▲ Premium Firearm Cleaner / Degreaser
- ▲ Premium Blend Firearm Lubricant



SPEC1 PREMIUM BLEND GREASE

- ▲ Similar Properties as the Premium Blend but in a Grease for Difficult Service Areas or Areas that Require Grease.
- ▲ 100% Synthetic



SIG MERCHANDISE

Show your SIG pride with a full line of SIG SAUER apparel, hats, and branded accessories. Choose from a wide range of sizes, men's or women's, and a variety of styles. There's something for everyone.

SIG MITCH ROSEN® LEATHER HOLSTERS

- ▲ Superior Quality Gunleather
- ▲ Professional Level Concealed Carry
- ▲ Custom Fit and Function
- ▲ Handmade in the U.S.A.



SIG BLACKPOINT™ TACTICAL HOLSTERS

- ▲ BlackPoint Manufactured Kydex
- ▲ Quality, Comfort and Concealability
- ▲ Built Specifically for SIG Pistols
- ▲ Made in the U.S.A.



SIG BRANDED HATS

- ▲ SIG Trucker Hat
- ▲ SIG Camo OHT Hat
- ▲ Flexfit Hats
- ▲ Snap Back Hats



SIG EYE PROTECTION

- ▲ SIG SAUER Branded
- ▲ Clear Polymer
- ▲ Adjustable Arms
- ▲ Ballistic Rated



SIG ELECTRONIC HEARING PROTECTION

- ▲ Noise Reduction Rating of 23dB
- ▲ Sound Activated Compression of 0.02 Seconds
- ▲ Compress Gun Shots Down to a Safe Level
- ▲ Uses 2 AAA Batteries (Included)



SIG APPAREL

- ▲ SIG SAUER T-Shirts
- ▲ Pullover Hoodies
- ▲ Zipper Pullovers
- ▲ Belts



KERSHAW® DROP POINT FOLDER

- ▲ Produced by Kershaw and RJ Martin
- ▲ 8Cr13MoV Steel 3" Blade
- ▲ Folds to 4"
- ▲ Brushed Nickel Latch
- ▲ SpeedSafe Assisted Flipper



PISTOL AMMUNITION



ELITE CARRY	V-CROWN	Caliber	Bullet Weight (grains)	Velocity in FPS MUZZLE 25 YDS 50 YDS 100 YDS	Energy in FT.-LBS MUZZLE 25 YDS 50 YDS 100 YDS	Trajectory in Inches 25 YDS 50 YDS 100 YDS	Product SKU
		380 AUTO	90	980 947 921 871	192 180 169 152	1.0 0.0 -9.8	E380A1-20
		9MM LUGER (365)	115	1050 1008 972 912	282 259 241 212	0.8 0.0 -8.7	E9MMA1-365-20
		9MM LUGER+P (M17)	124	1198 1137 1086 1006	395 356 325 279	N/A -0.0 -6.7	E9MMA2P-M17-20
		9MM LUGER	115	1185 1126 1076 1000	359 324 296 255	0.6 0.0 -7.0	E9MMA1-20
			124	1165 1102 1051 973	374 334 304 261	0.6 0.0 -7.3	E9MMA2-20
			147	985 958 934 891	317 300 285 259	0.9 0.0 -9.5	E9MMA3-20
		357 SIG	125	1356 1271 1197 1080	511 449 398 324	0.4 0.0 -5.6	E357S1-20
		38 SUPER +P	125	1230 1156 1095 1004	420 371 333 280	0.6 0.0 -6.7	E38SU1-20
		38 SPL +P	125	900 936 910 863	258 243 230 207	1.0 0.0 -10.0	E38SP1-20
		357 MAG	125	1450 1346 1252 1106	584 503 435 340	0.3 0.0 -5.1	E357M1-20
		40 S&W	165	1090 1048 1013 954	435 403 376 334	0.7 0.0 -8.0	E40SW1-20
			180	985 958 934 890	388 367 348 317	0.9 0.0 -9.4	E40SW2-20
		10MM AUTO	180	1250 1174 1111 1017	624 551 493 413	0.5 0.0 -6.5	E10MM1-20
		45 AUTO	185	995 953 917 855	407 373 345 300	0.9 0.0 -9.8	E45AP0-20
200	918 900 884 853		374 360 347 323	0.8 0.0 -10.1	E45AP1-20		
230	830 810 791 755		352 335 319 291	1.4 0.0 -13.4	E45AP2-20		
44 S&W SPL	200	700 685 671 643	218 208 200 184	2.1 0.0 -18.8	E44SP1-20		
44 REM MAG	240	1300 1231 1171 1075	901 807 730 615	0.5 0.0 -5.8	E44MA1-20		
45 LONG COLT	230	850 829 809 771	369 351 334 304	1.3 0.0 -12.7	E45LC1-20		

MATCH	V-CROWN	Caliber	Bullet Weight (grains)	Velocity in FPS MUZZLE 25 YDS 50 YDS 100 YDS	Energy in FT.-LBS MUZZLE 25 YDS 50 YDS 100 YDS	Trajectory in Inches 25 YDS 50 YDS 100 YDS	Product SKU
9MM LUGER	147	880 860 842 807	254 243 233 214	0.8 0.0 -11.4	E9MMA3-COMP-50		

ELITE TRAINING

	Caliber	Bullet Weight (grains)	Velocity in FPS				Energy in FT.-LBS				Trajectory in Inches			Product SKU
			MUZZLE	25 YDS	50 YDS	100 YDS	MUZZLE	25 YDS	50 YDS	100 YDS	25 YDS	50 YDS	100 YDS	
FMJ	380 AUTO	100	910	879	859	800	184	172	161	142	1.2	0.0	-11.5	E380B1-50
	9MM +P LEAD-FREE FRANGIBLE	90	1335	1210	1112	983	356	293	247	193	0.49	0.00	-6.51	E9MMLFF1-50
	9MM LUGER (365)	115	1050	1011	978	922	282	261	244	217	0.8	0.0	-8.6	E9MMB1-365-50
	9MM LUGER+P (M17)	124	1198	126	1067	979	395	349	314	264	N/A	0.0	-7.0	E9MMB2P-M17-50
	9MM LUGER	115	1185	1125	1076	999	359	323	296	255	0.6	0.0	-7.0	E9MMB1-50
		124	1165	1111	1065	993	374	340	312	272	0.6	0.0	-7.1	E9MMB2-50
		147	985	960	936	895	317	301	286	261	0.6	0.0	-9.4	E9MMB3-50
	357 SIG	125	1356	1246	1154	1024	506	427	367	389	0.5	0.0	-6.0	E357B1-50
	38 SUPER +P	125	1230	1166	1111	1026	420	377	343	292	0.5	0.0	-6.5	E38SUB-50
	38 SPL	125	900	881	863	829	225	215	207	191	1.2	0.0	-11.2	E38SB1-50
	357 MAG	125	1450	1330	1225	1072	584	491	417	319	0.4	0.0	-5.3	E357MB-50
	40 S&W	180	985	959	935	893	388	367	349	319	0.9	0.0	-9.4	E40SB2-50
10MM AUTO	180	1250	1185	1129	1042	624	561	510	434	0.5	0.0	-6.3	E10MB1-50	
45 AUTO	230	830	816	803	777	352	340	329	308	1.4	0.0	-12.9	E45BA3-50	
FMJ			Velocity in FPS				Energy in FT.-LBS				Trajectory in Inches			Product SKU
			MUZZLE	100 YDS	200 YDS	300 YDS	MUZZLE	100 YDS	200 YDS	300 YDS	MUZZLE	100 YDS	200 YDS	
	223 REM	55	3240	2875	2538	2225	1282	1009	787	605	0.0	-1.2	-7.9	E223B1-20
	308 WIN	150	2900	2667	2447	2236	2801	2370	1993	1665	0.0	-6.7	-25.9	E308B1-20
300 BLK	125	2145	1899	1672	1469	1277	1001	776	598	0.0	-1.2	-7.9	E300B1-20	



SPECIFICATIONS

RIFLE AMMUNITION



ELITE MATCH	MATCH GRADE	Caliber	Bullet Weight (grains)	Bullet Type	
		223 REM	77	OTM	
		6 MM CREEDMOOR	107	OTM	
		6.5 CREEDMOOR	140	OTM	
		260 REM	140	OTM	
		308 WIN	168	OTM	
			175		
		30-06	175	OTM	
		300 WIN MAG	190	OTM	
300 BLK	125	OTM			
300 BLK SUBSONIC	220	OTM			

ELITE HUNTING	TIPPED V&P	Caliber	Bullet Weight (grains)	Bullet Type	
		223 REM	40	TIPPED	
		22-250 REM	40	TIPPED	
		243 WIN	55	TIPPED	
		300 BLK SUBSONIC (9" BARREL)	205	TIPPED	

Ballistic Coefficient (G1)	Velocity in FPS	Energy in FT.-LBS	Trajectory in Inches	Product SKU
	MUZZLE 100 YDS 200 YDS 300 YDS 400 YDS 500 YDS	MUZZLE 100 YDS 200 YDS 300 YDS 400 YDS 500 YDS	100 YDS 200 YDS 300 YDS 400 YDS 500 YDS	
0.362	2750 2499 2262 2038 1828 1633	1293 1068 875 710 571 456	0.0 -4.1 -15.0 -34.3 -64.1	E223M1-20
0.527	2950 2771 2600 2434 2273 2118	2067 1824 1605 1407 1227 1066	0.0 -1.5 -8.2 -20.8 -40.1	E6MMCM2-20
0.535	2690 2410 2251 2099 1952 1810	2061 1806 1576 1369 1184 1018	0.0 -3.0 -12.9 -30.6 -57.3	E65CM1-20
0.527	2750 2579 2414 2255 2102 1955	2351 2067 1811 1580 1373 1188	0.0 -2.2 -10.4 -25.5 -48.4	E260M2-20
0.462	2719 2505 2314 2132 1967 1805	2720 2340 2003 1705 1443 1215	0.0 -4.1 -14.6 -32.8 -59.9	E308M1-20
0.496	2600 2424 2256 2094 1938 1791	2626 2284 1977 1703 1460 1246	0.0 -2.9 -12.7 -30.4 -57.4	E308M2-20
0.496	2700 2518 2342 2174 2013 1859	2833 2464 2132 1837 1575 1343	0.0 -1.7 -8.9 -22.3 -42.9	E3006M2-20
0.533	2850 2674 2505 2343 2186 2035	3426 3017 2648 2315 2016 1748	0.0 -3.4 -12.3 -27.5 -50.1	E3WMM1-20
	Velocity in FPS	Energy in FPS	Trajectory in Inches	
	MUZZLE 25 YDS 50 YDS 100 YDS	MUZZLE 25 YDS 50 YDS 100 YDS	25 YDS 50 YDS 100 YDS	
0.338	2150 2140 2080 1964	1343 1270 1201 1071	-1.1 -0.2 0.0	E300A1-20
0.608	1000 992 983 968	488 480 472 457	1.5 3.2 0.0	E300A2-20

Ballistic Coefficient (G1)	Velocity in FPS	Energy in FT.-LBS	Trajectory in Inches	Product SKU
	MUZZLE 100 YDS 200 YDS 300 YDS	MUZZLE 100 YDS 200 YDS 300 YDS	100 YDS 200 YDS 300 YDS	
0.196	3650 3089 2570 2093	1183 847 587 389	0.0 -0.7 -6.7	E223V1-20
0.196	3975 3390 2844 2346	1403 1021 718 489	0.0 -0.1 -4.5	E225V1-20
0.225	3880 3377 2928 2496	1838 1393 1047 761	0.0 -0.1 -4.2	E243V1-20
	Velocity in FPS	Energy in FPS	Trajectory in Inches	
	MUZZLE 25 YDS 50 YDS 100 YDS	MUZZLE 25 YDS 50 YDS 100 YDS	25 YDS 50 YDS 100 YDS	
0.445	922 914 905 897 890	387 380 373 367 360	-0.2 0.0 -7.6	E300H2-20

RIFLE AMMUNITION



ELITE HUNTING	COPPER	CALIBER	Bullet Weight (grains)	Bullet Type
		223 REM	60	HT
		300 BLK	120	HT
		243 WIN	80	HT
		6MM CREEDMOOR	80	HT
		6.5 CREEDMOOR	120	HT
		308 WIN	150	HT
		260 REM	120	HT
		270 WIN	130	HT
		30-06 SPRG	150	HT
300 WIN MAG	165	HT		

ELITE HUNTER	TIPPED	CALIBER	Bullet Weight (grains)	Bullet Type
		243 WIN	90	Lead Core Tipped
		6 MM CREEDMOOR	100	
		6.5 CREEDMOOR	130	
		260 REM	130	
		270 WIN	150	
		7MM REM MAG	165	
		308 WIN	165	
		30-06 SPRG	165	
		300 WIN MAG	180	

	Ballistic Coefficient (G1)	Velocity in FPS MUZZLE 100 YDS 200 YDS 300 YDS	Energy in FT.-LBS MUZZLE 100 YDS 200 YDS 300 YDS	Trajectory in Inches 100 YDS 200 YDS 300 YDS	Product SKU
	0.240	3100 2704 2340 2006	1280 974 730 536	0.0 -1.8 -10.0	E223H1-20
	0.290	2250 2190 2131 2015	1405 1331 1260 1127	-1.54 -.54 0.0	E300H1-20
	0.320	3425 3101 2800 2519	2083 1708 1393 1127	0.0 -0.6 -5.7	E243H1-20
	0.340	3375 3073 2779 2499	2024 1678 1372 1109	0.0 -0.7 -5.9	E6MMCH1-20
	0.380	2825 2586 2359 2143	2126 1781 1748 1224	0.0 -2.2 -10.7	E65CH1-20
	0.400	2900 2669 2449 2239	2801 2372 1997 1670	0.0 -1.9 -9.6	E308H1-20
	0.380	2880 2638 2408 2190	2210 1854 1545 1278	0.0 -2.0 -10.0	E260H1-20
	0.380	3050 2798 2560 2335	2685 2260 1892 1573	0.0 -1.4 -8.2	E270H1-20
	0.342	2920 2644 2385 2140	2841 2329 1895 1526	0.0 -2.0 -10.0	E3006H1-20
	0.410	3110 2873 2649 2435	3543 3024 2570 2172	0.0 -1.2 -7.4	E3WMH1-20

	Ballistic Coefficient (G1)	Velocity in FPS MUZZLE 100 YDS 200 YDS 300 YDS 400 YDS 500 YDS	Energy in FT.-LBS MUZZLE 100 YDS 200 YDS 300 YDS 400 YDS 500 YDS	Trajectory in Inches 100 YDS 200 YDS 300 YDS 400 YDS 500 YDS	Product SKU
	0.400	3115 2916 2725 2543 2367 2199	1939 1699 1484 1292 1120 966	0.0 -1.1 -6.9 -18.0 -35.4	E243TH2-20
	0.515	2970 2786 2610 2441 2277 2120	1958 1724 1512 1322 1151 998	0.0 -1.5 -8.1 -20.5 -39.7	E6MMCTH2-20
	0.510	2850 2670 2496 2329 2169 2015	2344 2057 1798 1566 1357 1171	0.0 -1.9 -9.4 -23.3 -44.5	E65CMTTH1-20
	0.510	2820 2641 2468 2303 2143 1990	2295 2013 1769 1530 1326 1143	0.0 -2.0 -9.7 -24.0 -45.8	E260TH1-20
	0.508	2950 2765 2587 2416 2252 2093	2705 2376 2084 1814 1576 1363	0.0 -1.6 -8.3 -21.0 -40.6	E270TH2-20
	0.575	3000 2834 2674 2520 2371 2227	2997 2675 2381 2115 1872 1651	0.0 -1.3 -7.5 -19.2 -37.1	E7RMTH2-20
	0.530	2840 2667 2500 2339 2184 2035	2955 2605 2289 2004 1747 1517	0.0 -1.9 -9.4 -23.2 -44.3	E308TH2-20
	0.530	2950 2772 2601 2437 2278 2126	3188 2815 2479 2175 1902 1655	0.0 -1.5 -8.2 -20.7 -40.0	E3006TH2-20
	0.515	2960 2777 2601 2432 2269 2112	3501 3081 2703 2363 2057 1783	0.0 -1.5 -8.2 -20.7 -40.0	E3WMTH3-20



SPECIFICATIONS

ELECTRO-OPTICS SPECIFICATIONS

SIERRA6™ BDX

Model	Focal Plane	Reticle	ADJ.	Exit Pupil		Linear Field of View				Eye Relief				Objective Filter Thread	Objective Clear Aperture		Weight		Elevation Adjustment Range	Windage Adjustment Range	Illumination Settings	Length	
				MM		FT @ 100 yards		M @ 100 M		INCH		MM			INCH	MM	OUNCE	GRAM				INCH	MM
				LOW	HIGH	LOW	HIGH	LOW	HIGH	LOW	HIGH	LOW	HIGH										
2-12 x 40 mm	Second	BDX-R2 Digital Focal Plane OLED	.25 MOA	8.4	3.3	52.5	8.7	16.0	2.7	3.7	3.9	94	99	M 42 x 0.75	1.6	40	21.4	606	60 MOA	60 MOA	8 daytime/ 2 NV	10.75	273
3-18 x 44 mm	Second	BDX-R2 Digital Focal Plane OLED Ballistic w/ Side Focus	.25 MOA	8.2	2.4	34.9	5.8	10.6	1.8	3.7	3.9	94	99	M 46 x 0.75	1.7	44	23.8	674	60 MOA	60 MOA	8 daytime/ 2 NV	12.25	311
5-30 x 56 mm	Second	BDX-R2 Digital Focal Plane OLED Ballistic w/ Side Focus	.25 MOA	8.1	1.9	21.0	3.5	6.4	1.0	3.7	3.9	94	99	M 58 x 0.75	2.2	56	30.4	862	60 MOA	60 MOA	8 daytime/ 2 NV	14.75	375

SIERRA3™ BDX

Model	Focal Plane	Reticle	ADJ.	Exit Pupil		Linear Field of View				Eye Relief				Objective Filter Thread	Objective Clear Aperture		Weight		Elevation Adjustment Range	Windage Adjustment Range	Illumination Settings	Length	
				MM		FT @ 100 yards		M @ 100 M		INCH		MM			INCH	MM	OUNCE	GRAM				INCH	MM
				LOW	HIGH	LOW	HIGH	LOW	HIGH	LOW	HIGH	LOW	HIGH										
2.5-8 x 32 mm	Second	BDX-R1 Digital Focal Plane OLED Ballistic	.25 MOA	8.8	4.0	39.8	13.2	12.1	4.0	4.2	3.5	106.9	87.9	M 25.5 x 0.5	0.9	24	19.4	550	80 MOA	80 MOA	10 daytime/ 2 NV	12.75	324
3.5-10 x 42 mm	Second	BDX-R1 Digital Focal Plane OLED Ballistic	.25 MOA	8.8	4.2	27.8	9.4	8.47	2.9	4.2	3.5	106.9	87.9	M 25.5 x 0.5	0.9	24	20.9	593	55 MOA	55 MOA	10 daytime/ 2 NV	12.75	324
4.5-14 x 44 mm	Second	BDX-R1 Digital Focal Plane OLED Ballistic w/ Side Focus	.25 MOA	6.9	3.1	19.9	6.7	6.06	2.0	4.2	3.4	106.9	86	M 46 x 0.75	1.7	42	23.2	658	55 MOA	55 MOA	10 daytime/ 2 NV	12.6	320
4.5-14 x 50 mm	Second	BDX-R1 Digital Focal Plane OLED Ballistic w/ Side Focus	.25 MOA	8.9	3.6	19.9	6.7	6.06	2.0	3.6	4.2	85.1	106.9	M 46 x 0.75	1.8	44	24.9	706	55 MOA	55 MOA	10 daytime/ 2 NV	12.75	324
6.5-20 x 52 mm	Second	BDX-R1 Digital Focal Plane OLED Ballistic w/ Side Focus	.25 MOA	6.1	2.6	14.1	4.7	1.4	1.4	4.2	3.5	106.9	87.1	M 52 x 0.75	2.0	50	25.9	734	40 MOA	40 MOA	10 daytime/ 2 NV	14.25	362

KILOBDX™

Model	Magnification	Objective Clear Aperature	Exit Pupil MM	Eye Relief MM	Angular (FOV)	FOV@ 100 YDS	Range Response Time	Laser Divergence	Scanning	Range Resolution Under 100 YDS	Max Range			Weight with Battery		Length	
											REFLECTIVE	DEER	TREES	OZ	G	IN	MM
KILO3000™ BDX	10x	42 mm	4.2	18	6.1	32.0 ft	.25 sec	1.5 MRAD	yes	+/- 0.1 yds	Up to 5000 yds	Up to 1500 yds	Up to 2000 yds	32.0	907	5.2	145
KILO2400™ BDX	7x	25 mm	3.6	15	6.8	35.7 ft	.25 sec	1.4 MRAD	yes	+/- 0.1 yds	Up to 3400 yds	Up to 1400 yds	Up to 1800 yds	7.5	215	4.4	112
KILO2200™ BDX	7x	25 mm	3.6	15	6.8	35.7 ft	.25 sec	1.4 MRAD	yes	+/- 0.1 yds	Up to 3400 yds	Up to 1300 yds	Up to 1600 yds	7.5	215	4.4	112
KILO1800™ BDX	6x	22 mm	3.7	17	6.0	34.2 ft	.25 sec	1.3 MRAD	yes	+/- 0.1 yds	Up to 2000 yds	Up to 1000 yds	Up to 1200 yds	7.9	225	4.0	103
KILO1600™ BDX	6x	22 mm	3.7	17	6.0	34.2 ft	.25 sec	4.00 MRAD	yes	+/- 0.1 yds	Up to 2000 yds	Up to 1000 yds	Up to 1200 yds	6.4	180	4.3	109
KILO1400™ BDX	6x	20 mm	3.3	15	6.5	34.2 ft	.25 sec	3.33 MRAD	yes	+/- 0.1 yds	Up to 1600 yds	Up to 750 yds	Up to 950 yds	5.3	150	3.7	95
KILO1000™ BDX	5x	20 mm	4.0	18	7.5	39.5 ft	.25 sec	2.00 MRAD	yes	+/- 0.1 yds	Up to 1200 yds	Up to 800 yds	Up to 1000 yds	5.2	147	4.3	109

KILO™

KILO2400ABS™	7x	25 mm	3.6	15	6.8	35.7 ft	.25 sec	1.4 MRAD	yes	+/- 0.1 yds	Up to 2000 yds	Up to 1400 yds	Up to 1800 yds	7.5	215	4.2	107
KILO1600™	6x	22 mm	3.7	17	6.0	34.1 ft	.25 sec	4.00 MRAD	yes	+/- 0.1 yds	Up to 2000 yds	Up to 1000 yds	Up to 1200 yds	6.4	180	4.3	109
KILO1000™	5x	20 mm	4.0	18	7.5	39.5 ft	.25 sec	2.00 MRAD	yes	+/- 0.1 yds	Up to 1200 yds	Up to 800 yds	Up to 1000 yds	5.2	147	4.3	109

ECHO™

Model	Magnification	Eye Relief	Field of View	Frame Rate	Runtime	Color / Contrast Settings	Close Focus Distance	Spectral Response	Digital Elevation Adjustment Range	Weight		Length		Width		Height	
										OZ	G	IN	MM	IN	MM	IN	MM
ECHO3™	1-6 x 23mm	Unlimited	10°	30Hz	6 hrs	11 Color Paletts 6 Brightness Levels	3 ft	9-14 um, 320x240-12 um VOx LWIR Core	150 MOA x 150 MOA	14.3	405	4.3	109	2.6	66	3.3	84

XRAY™

Model	Housing	Illumination	Front Sight	Rear Sight	Sight Picture
X-RAY3™	Steel	Tritium	High Contrast Green Outline	Subtle Black Outline	3 Dot
X-RAY1™	Steel	Fiber Optic	Luminescent	Luminescent	3 Dot



ELECTRO-OPTICS SPECIFICATIONS

TANGO6™

Model	Focal Place	Reticle	ADJ.	Exit Pupil		Linear Field of View				Eye Relief				Objective Filter Thread	Objective Clear Aperture		Weight		Elevation Adjustment Range	Windage Adjustment Range	Illumination Settings	Length	
				MM	MM	FT @ 100 yards		M @ 100 M		INCH		MM			INCH	MM	OUNCE	GRAM				INCH	MM
				LOW	HIGH	LOW	HIGH	LOW	HIGH	LOW	HIGH	LOW	HIGH		LOW	HIGH							
1-6X24 mm	First	5.56MM / 7.62MM 300 Blackout Horseshoe Dot	0.2 MOA	11.4	4.0	105.8	17.7	35.3	5.9	4.09	3.93	100	M 25.5 x 0.6	0.9	24	22.0	626	106.5 MOA 31 MRAD	106.5 MOA 31 MRAD	9 Daylight/ 2 NV	10.8	275	
		7.62 Extended Range	0.2 MOA																				
		DWLR6	0.2 MOA																				
1-6X24 mm	Second	M855A1 HELLFIRE®	0.2 MOA	106.9	35.6	4.05	103	20.8	590	10.5	268												
		MOA MILLING HELLFIRE	0.5 MOA																				
		3-Gun HELLFIRE	0.2 MOA																				

TANGO6™

3-18 x 44 mm	First	MOA Milling	.25 MOA	12	2.4	32	5.8	10.7	1.9	3.74	3.7	95	94	M 46 X 0.75	1.7	44	37.57	1065	95 MOA 27.6 MRAD	95 MOA 27.6 MRAD	7 Daytime/ 2 NV	12.38	315
		MRAD Milling	0.1 MRAD																				
		MOA DEV-L	0.25 MOA																				
		MRAD DEV-L	0.1 MRAD																				
5-30 x 56 mm	First	MOA Milling	.25 MOA	8.9	1.9	18.9	3.3	6.3	1.1	3.6	3.5	92	89	M 58 x 0.75	2.2	56	42	1191	80 MOA 23.2 MRAD	50 MOA 14.5 MRAD	14.38	365	
		MRAD Milling	0.1 MRAD																				
		MOA DEV-L	0.25 MOA																				
		MRAD DEV-L	0.1 MRAD																				

TANGO4™

1-4X24 mm	First	5.56/7.62 Horseshoe Dot	0.5 MOA	15.4	6.1	98	24	32.7	8	3.3	3.3	84	84	M 46 x 0.75	0.9	24	15.9	450	180 MOA 52 MRAD	180 MOA 52 MRAD	8 Daylight/ 2 NV	10.0	275
		300 Blackout Horseshoe Dot	0.5 MOA																				
		MOA Milling	0.5 MOA																				
		MRAD Milling	0.2 MRAD																				
4-16X44 mm	First	DEV-L MOA	0.25 MOA	10.6	2.7	24.1	6.3	6.3	24.1	3.3	3.3	84	84	M 46 x 0.75	0.9	24	20.5	581	90 MOA 26 MRAD	80 MOA 23 MRAD	8 Daylight/ 2 NV	13.6	345
		DEV-L MRAD	0.1 MRAD																				
		MOA Milling	0.25 MOA																				
		MRAD Milling	0.1 MRAD																				
6-25X50 mm	First	DEV-L MOA	0.25 MOA	8	2.1	14.7	3.7	5.3	1.4	3.3	3.3	84	84	M 52 x 0.75	2.0	50	22.9	649	60 MOA 17 MRAD	30 MOA 8.5 MRAD	8 Daylight/ 2 NV	15.6	307.2
		DEV-L MRAD	0.1 MRAD																				
		MOA Milling	0.25 MOA																				
		MRAD Milling	0.1 MRAD																				

WHISKEY5™

Model	Focal Place	Reticle	ADJ.	Exit Pupil MM		Linear Field of View				Eye Relief				Objective Filter Thread	Objective Clear Aperture		Weight		Elevation Adjustment Range	Windage Adjustment Range	Illumination Settings	Length	
				LOW	HIGH	FT @ 100 yards		M @ 100 M		INCH		MM			INCH	MM	OUNCE	GRAM				INCH	MM
						LOW	HIGH	LOW	HIGH	LOW	HIGH	LOW	HIGH		LOW	HIGH							
2-10 X 42 mm	Second	Hellfire Quadplex	0.25 MOA	10.7	4.2	49.1	9.8	16.4	3.3	4	4.1	101	104	M46 x .75	1.7	44	21.9	623	100	100	9 daylight/ 2 NV	11.5	292
		MRAD Milling Hunter	0.1 MRAD																				
		MOA Milling Hunter	0.5 MOA																				
2.4-12 X 56 mm	Second	Hellfire Triplex	0.1 MRAD	11.6	4.7	43.1	9.3	14.3	3.1	3.9	4	98	100	M58 x .75	2.2	56	28.8	816	62	62	7 daylight/ 2 NV	14.8	376
		MRAD Milling Hunter	0.1 MRAD																				
3-15 X 44 mm	Second	Hellfire Quadplex	0.25 MOA	10	2.9	34.1	6.8	11.4	2.3	3.9	4	98	100	M46 x .75	1.7	44	25.1	712	70	45	7 daylight/ 2 NV	12.5	317
		MRAD Milling Hunter	0.1 MRAD																				
		MOA Milling Hunter	0.25 MOA																				
3-15 X 52 mm	Second	Hellfire Quadplex	0.25 MOA	10	3.5	34.1	6.8	6.7	2.3	3.9	3.9	98	99	M54 x .75	2	52	27.8	788	75	75	7 daylight/ 2 NV	12.5	317
		MRAD Milling Hunter	0.1 MRAD																				
		MOA Milling Hunter	0.25 MOA																				
5-25 X 52 mm	Second	Hellfire Quadplex	0.25 MOA	10	2.1	20.2	4	1.3	1.3	3.8	3.8	97	97	M54 x .75	2	52	28.8	816	50	50	7 daylight/ 2 NV	13.5	343
		MRAD Milling Hunter	0.1 MRAD																				
		MOA Milling Hunter	0.25 MOA																				

WHISKEY3™

Model	Focal Place	Reticle	ADJ.	Exit Pupil MM		Linear Field of View				Eye Relief				Objective Clear Aperture		Weight		Elevation Adjustment Range	Windage Adjustment Range	Length	
				LOW	HIGH	FT @ 100 yards		M @ 100 M		INCH		MM		INCH	MM	OUNCE	GRAM			INCH	MM
						LOW	HIGH	LOW	HIGH	LOW	HIGH	LOW	HIGH	LOW	HIGH						
2-7 X 32 mm	Second	Quadplex	0.25 MOA	10.6	4	47.1	13.75	15.7	4.5	3.6	3.6	88.9	88.9	1.2	32	14.3	405	90	90	11.5	292
		BDC-1 Quadplex																			
3-9 X 40 mm	Second	Quadplex	0.25 MOA	13.3	4.4	35	11.89	11.7	4	3.6	3.6	88.9	88.9	1.6	40	15.3	434	80	80	12.4	315
		Hellfire Quadplex														16.4	465				
		BDC-1 Quadplex														15.3	434				
3-9 X 50 mm	Second	Quadplex	0.25 MOA	16.6	2.9	35	11.89	11.7	4	3.6	3.6	88.9	88.9	1.9	50	18.1	513	80	80	12.6	320
		Hellfire Quadplex														18.9	536				
		BDC-1 Quadplex														18.1	513				
4-12 X 40 mm	Second	Quadplex	0.25 MOA	10	3.5	24.8	8.27	8.24	2.74	3.6	3.6	88.9	88.9	1.6	40	16.6	470	60	60	12.5	318
		Hellfire Quadplex														17.6	495				
		BDC-1 Quadplex														16.6	470				
4-12 X 50 mm	Second	Quadplex	0.25 MOA	12.5	2.1	24.8	8.27	8.24	2.74	3.6	3.6	88.9	88.9	2	50	17.5	500	60	60	12.6	322
		Hellfire Quadplex														18.5	525				
		BDC-1 Quadplex														17.6	500				

SPECIFICATIONS

ELECTRO-OPTICS SPECIFICATIONS

ROMEOTM

Model	Magnification	Eye Relief	Objective Clear Aperature	Red Dot Size	Illumination Settings	Elevation Adjustment Range	Windage Adjustment Range	Weight		length		width		height		
								oz	g	IN	MM	IN	MM	IN	MM	
ROMEZero™	1x	Unlimited		3 MOA / 6 MOA	8 Daytime / 2 NV	90 MOA	120 MOA	.4	14	1.6	40.8	.93	23.7	.93	28.7	NEW
ROMEOPRO™	1x	Unlimited	30 mm	3 MOA / 6 MOA	10 Daytime / 2 NV	100 MOA	100 MOA	1.0	28	1.8	46.5	1.2	31.7	1.1	27.4	NEW
ROME01™	1x	Unlimited	30 mm	3 MOA	5 Daytime / 2 NV	100 MOA	100 MOA	.8	24	1.8	44.9	1.3	32.8	1.1	27.4	
ROME03™	1x	Unlimited	25 mm	3 MOA	8 Daytime / 2 NV	100 MOA	100 MOA	1.4	40	2.4	60	1.1	28	1.65	42	
ROME03XL™	1x	Unlimited	35 mm	3 MOA / 6 MOA	10 Daytime / 2 NV	80 MOA	80 MOA	1.5	43	2.0	54	1.41	36	1.4	35	NEW
ROME03MAX™	1x	Unlimited	30 mm	3 MOA / 6 MOA	10 Daytime / 2 NV	80 MOA	80 MOA	1.5	43	2.0	54	1.29	33	1.4	35	NEW
ROME04T™	1x	Unlimited	20 mm	2 MOA / 1 MOA	10 Daytime / 2 NV	100 MOA	100 MOA	3.2	91	3.3	84.6	1.86	47.85	2.46	62.6	
ROME04DR™	1x	Unlimited	20 mm	2 MOA	10 Daytime / 2 NV	100 MOA	100 MOA	7.6	215	3.4	86	1.82	46.2	2.5	63.5	
ROME04S™	1x	Unlimited	20 mm	2 MOA / 1 MOA	10 Daytime / 2 NV	100 MOA	100 MOA	7.6	215	3.4	85.6	1.8	46	2.5	63.5	
ROME04H™	1x	Unlimited	20 mm	2 MOA	10 Daytime / 2 NV	100 MOA	100 MOA	7.6	215	3.4	86	1.82	46.2	2.5	63.5	
ROME05XDR™	1x	Unlimited	20 mm	2 MOA or 2 MOA DOT	8 Daytime / 2 NV	+/- 40 MOA	+/- 40 MOA	5.6	159	2.5	63.5	1.4	35.6	2.6	66	
ROME05X™	1x	Unlimited	20 mm	2 MOA	8 Daytime / 2 NV	100 MOA	100 MOA	5.6	159	2.5	63.5	1.4	35.6	2.6	66	
ROME05 TREAD™	1x	Unlimited	20 mm	2 MOA	8 Daytime / 2 NV	100 MOA	100 MOA	5.1	145	2.5	62.7	1.5	38.1	1.5	38.6	
ROME05™	1x	Unlimited	20 mm	2 MOA	8 Daytime / 2 NV	+/- 60 MOA	+/- 60 MOA	4.8	136	2.9	75	1.6	41	1.4	36	
ROME07™	1x	Unlimited	30 mm	2 MOA	8 Daytime / 2 NV	200 MOA	150 MOA	12.5	356	4.8	120	2	51	3	76.2	
ROME08T™	1x	Unlimited	1.25 in x .91 in	5.56 mm / 7.62 mm	10 Daytime / 2 NV	+/- 70 MOA	+/- 70 MOA	13.7	388	3.5	89.4	1.97	50	2.8	71	
ROME08H™	1x	Unlimited	1.25 in x .91 in	5.56 mm / 7.62 mm	10 Daytime / 2 NV	+/- 70 MOA	+/- 70 MOA	10.3	292	3.5	89.4	1.97	50	2.8	71	
ROME0-MSR™	1x	Unlimited	20 mm	2 MOA	10 Daytime / 2 NV	100 MOA	100 MOA	4.9	139	3.1	79	1.5	38	2.6	66	NEW

JULIET™

Model	Magnification	Field of View	Clear Aperture	Exit Pupil	Eye Relief	Diopter Range	Adjustment Range	Weight		Length		Width		Height	
								OZ	G	IN	MM	IN	MM	IN	MM
JULIET6™	6x	4°	24 mm	4 mm	59 mm	+/- 2	+/- 30 MOA	14.7	416	5.4	137.16	1.95	49.3	2.9	73.6
JULIET4™	4x	6.25°	24 mm	6 mm	65 mm	+/- 2	+/- 45 MOA	12.5	257	4.2	107	2.1	53	2.6	66
JULIET3™	3x	8°	24 mm	8 mm	65 mm	+/- 2	+/- 55 MOA	12.5	257	4.2	107	2.0	71	2.8	70

BRAVO™

Model	Magnification	Field of View	Eye Relief	Prism Coating	Illumination	Motion Sensor	Waterproof	Weight		Length		Width		Height	
								OZ	G	IN	MM	IN	MM	IN	MM
BRAVO5™	5x	6°	60 mm	Dielectric	12 Settings, RED	Yes, MOTAC, 2 Min Auto-Off	IPX-7	23	652	6.4	163.3	2.6	65.4	2.9	74.9
BROVO3™	3x	10°	60 mm	Dielectric	12 Settings, RED	Yes, MOTAC, 2 Min Auto-Off	IPX-7	22	624	6.4	163.3	2.6	65.4	2.9	74.9

OSCAR™

Model	Magnification	Exit Pupil	Clear Aperture	Close Focus Distance	Eye Relief	Linear FOV M at 1000 Yards	Linear FOV M at 1000 M	Angular FOV	Waterproof Level @ 1 M Eye Piece Attached	Weight		Length		Width		Height	
										OZ	G	IN	MM	IN	MM	IN	MM
OSCAR8™	27-50 x 80	2.96 mm / 1.45 mm	80 mm	5 m	17-16 mm	105-73 ft	35-24 m	2° - 1.4°	5 min	68	1928	15.27	388	4.0	102	6.11	155
OSCAR3™	10-20 x 30	3.0 mm / 1.5 mm	30 mm	6 m	23-15 mm	179-126 ft	54.6-38.4 m	3.4° / 2.4°		16	454	6.7	170.2				

LIMA™

Model	Laser	Operating Mode	Run Time		Adjustment	Spot Size	Weight		Length		Width		Height	
			Red	Green			OZ	G	IN	MM	IN	MM	IN	MM
LIMA1™	Class 3R Red or Green	Momentary or Continuous	> 5 Hours	> 2 Hours	Windage + Elevation	.5 @ 50 ft	1.6	45	2.0	51	1.2	31	0.85	22
LIMA320™	Class 3R Red or Green	Momentary	> 5 Hours	> 3 Hours	Windage + Elevation	.5 @ 50 ft	4.0	113.4	7.1	180.5	1.32	33.6	4.2	106.3
LIMA38™	Class 3R Red or Green	Momentary or Continuous	> 8 Hours	NA	Windage + Elevation	.5 @ 50 ft	0.6	17	2.5	63.5	0.7	18.3	1.4	34.3
LIMA365™	Class 3R Red or Green	Instant Activation	> 4 Hours	> 2 Hours	Windage + Elevation	.5 @ 50 ft	1.3	37	3.8	96.5	1.0	25.4	1.9	48.3

ELECTRO-OPTICS SPECIFICATIONS

ZULU™

Model	Magnification	Exit Pupil	Clear Aperture	Close Focus Distance	Interpupillary Distance	Diopter Range	Eye Relief	Linear FOV M @ 1000 Yards	Linear FOV M @ 1000 M	Angular FOV	Weight		Length	
											OZ	G	IN	MM
ZULU9™	9 X 45	5 mm	45 mm	6 ft	56 mm - 79 mm	+/- 3	17.3 mm	378 ft	126 m	7.2°	33	950	7.5	190.5
	11 X 45	4.1 mm	45 mm	6 ft	56 mm - 74 mm	+/- 3	16.7 mm	315 ft	105 m	6.0°	33	950	7.5	190.5
	15 X 56	3.8 mm	56 mm	9 ft	56 mm - 79 mm	+/- 3	17.8 mm	236 ft	78.7 m	4.5°	43	1220	7.5	190.5
ZULU7™	8 x 42	5.3 mm	42 mm	5.9 ft	56 mm - 74 mm	+/- 3	20 mm	378 ft	126 m	7.2°	33	950	5.8	147.3
	10 x 42	4.2 mm	42 mm	5.9 ft	56 mm - 74 mm	+/- 3	17 mm	341 ft	114 m	6.5°	33	950	5.8	147.3
	12 x 50	4.2 mm	50 mm	6.5 ft	56 mm - 75 mm	+/- 3	16.6 mm	273 ft	91.0 m	5.2°	31.9	905	6.8	172.7
ZULU5™	8 x 42	6.3 mm	42 mm	6.5 ft	56 mm - 74 mm	+/- 3	17 mm	393 ft	131 m	7.5°	24.5	694.5	6.0	152.4
	10 x 42	4.2 mm	42 mm	8.2 ft	56 mm - 74 mm	+/- 3	15 mm	315 ft	105 m	6.0°	24.5	694.5	6.0	152.4
	12 x 42	3.5 mm	42 mm	8.2 ft	56 mm - 74 mm	+/- 3	15 mm	252 ft	84.0 m	4.8°	21.5	609	5.7	145
	12 x 50	4.2 mm	50 mm	8.2 ft	56 mm - 74 mm	+/- 3	15.5 mm	252 ft	84.0 m	4.8°	29.5	836	6.6	168
ZULU3™	8 x 32	4.0 mm	32 mm	8.2 ft	56 mm - 74 mm	+/- 3	14.5 mm	393 ft	131 m	7.5°	14.0	397	5.5	139.7
	10 x 32	3.2 mm	32 mm	8.2 ft	56 mm - 74 mm	+/- 3	14.5 mm	341 ft	114 m	6.5°	16.0	454	5.5	139.7

FOXTROT™

Model	Led Output	Operating Mode	Runtime @ 200 Lumens	Weight		Length		Width		Height	
				OZ	G	IN	MM	IN	MM	IN	MM
FOXTROT365™	100 + Lumens	Instant Activation	> 30 min / 3 hours	1.3	37	3.8	96.5	1.0	25.4	1.9	48.3
FOXTROT1™	100 / 200 / 300 Lumens	Momentary or Continuous	> 2 Hours	3.0	84	3.1	79.0	1.2	31.0	1.2	3.1



SIG AIR SPECIFICATIONS

SIG AIR PISTOLS

Model	Caliber / Mag Cap.			Velocity (up to)		Measurements (in)				Weight (lb)	Operating System	Construction	Sights
	.177 cal	.22 cal	6.0 mm	FPS	FPE	Length	Height	Width	Barrel Length				
SUPER TARGET	1			350	2.0	10.0	6.3	1.4	7.5	3.5	Single Stroke Pneumatic	Metal / wood grips	Rear Adjustable
M17	20			430	3.0	8.0	6.5	1.3	5.0	2.15	CO2	Metal / Poly	White Dot
365 BB	12			295	0.07	5.75	4.5	1.0	3.2	1.0	CO2	Metal / Poly	3 DOT High Visibility Fixed Sights
WTP BB			17	410	2.0	8.8	6.0	1.2	4.6	2.8	CO2	Metal	White Dot
1911 BB			16	410	2.0	8.7	6.0	1.4	4.6	2.6	CO2	Metal	White Dot
XFIVE [®]	20			430	3.0	9.0	6.5	1.5	4.6	3.0	CO2	Metal	White Dot
P226 [®]	16			480	4.0	8.0	5.2	1.5	3.9	2.6	CO2	Metal	White Dot
P320 [®]	30			310	2.0	7.9	5.6	1.3	5.0	1.7	CO2	Metal / Poly	White Dot
M17 PROFORCE			21	410 / 320	0.07 / 0.05	8.5	6.5	1.3	5.0	2.25	CO2 / GG	Metal / Poly	White Dot / Mount Plate
M18 PROFORCE			21	410 / 320	0.07 / 0.05	7.5	6.5	1.3	4.0	2.0	CO2 / GG	Metal / Poly	White Dot / Mount Plate
229 PROFORCE			23	295	0.04	7.5	5.2	1.25	4.5	2.5	GG	Metal / Poly	White Dot

SIG AIR RIFLES

Model	Caliber / Mag Cap.			Velocity (up to)		Measurements (in)				Weight (lb)	Operating System	Construction	Sights / Optics			
	.177 cal	.22 cal	6.0 mm	FPS .177 / .22 CAL	FPE .177 / .22 CAL	Length	Height	Width	Barrel Length				Flip-Up	20mm SIG 20R Red Dot Optic	1-4 x24 Scope	WHISKEY ASP Scope
ASP20	1	1		1020 / 840	20/23	45.5	6.0	1.5	14.0	8.5 lb	Gas Piston	Steel and Wood / Syn Stock				
VIRTUS		30		700	12	37.5	9.0	2.3	18.0	7.5 lb	Pre-Charged Pneumatic	Metal / Poly	•			
MCX	30			700	5.71	34.7	8.8	1.5	18.0	7.0 lb	CO2	Metal / Poly	•	•	•	
MPX	30			575	3.86	25.7	8.5	1.3	8.0	6.0 lb	CO2	Metal / Poly	•	•		
MCX PROFORCE			120	375	0.06	29.0	9.0	1.5	11.5	7.0 lb	Automatic Electric Gun	Metal				

PISTOL SPECIFICATIONS

Pistol Models	Caliber / Magazine Capacity						Action Type				Measurements					Weight w/Mag	
	.380ACP	9mm	.357SIG	.40S&W	.45ACP	10mm	DA/SA	SRT* (DA/SA)	SAO	STRIKER	Length (in)	Height (in)	Width (in)	Barrel Length (in)	Sight Radius (in)	Alloy/Poly (oz)	Stainless (oz)
P210* TARGET		8						•			8.4	5.3	1.6	5.0	6.7		36.9
P220*					8			•	•		7.7	5.5	1.3	4.4	6.3	30.4	39.1
P220 R5 (5" BARREL)						8	•	•	•		8.3	5.5	1.5	5.0	6.9		44.0
P226*		15					•	•	•		7.7	5.5	1.5	4.4	6.3	34.4	42.2
P229*		15					•	•	•		7.1	5.4	1.5	3.9	5.7	32.0	
P320* M17		17/21								•	8.0	5.5	1.6	4.7	6.6	29.5	
P320 M18		17/21								•	7.2	5.5	1.6	3.9	5.8	26.5	
P320 FULL-SIZE		17								•	8.0	5.5	1.3	4.7	6.6	29.5	
P320 COMPACT		15	13	13	9					•	7.2	5.3	1.3	3.9	5.8	25.8	
P320 RXP FULL-SIZE		17/21								•	8.0	6.2	1.4	4.7	6.6	30.3	
P320 RXP COMPACT		15								•	7.2	6.0	1.4	3.9	5.8	26.1	
P320 XFIVE LEGION		17/21								•	8.5	5.8	1.6	5.0	6.9	43.5	
P320 XFULL		17/21								•	8.2	5.5	1.3	4.7	6.6	29.5	
P320 XCOMPACT		15								•	7.0	5.3	1.3	3.6	5.5	25.3	
P320 XFULL RXP		17/21								•	8.2	5.5	1.4	4.7	6.6	29.5	
P320 XCOMPACT RXP		15								•	7.0	5.3	1.4	3.6	5.5	25.3	
P320 XCARRY TACOPS		17/21								•	8.1	5.8	1.6	4.6	5.8	28.5	
P320 XVTAC		17/21								•	8.2	5.6	1.3	4.7	6.6	29.5	
SP2022*		15		12			•				7.4	5.7	1.4	3.9	5.9	29.0	
1911					8	8			•		8.7	5.5	1.4	5.0	6.5		41.6
1911 CARRY					8				•		7.7	5.5	1.4	4.2	5.7		38.8
P938*		6/7							•		5.9	3.9	1.1	3.0	4.0	16.0	
P238*	6/7								•		5.5	3.9	1.1	2.7	3.8	15.2	18.0
P365*		10/12								•	5.8	4.3	1.0	3.1	4.7	17.8	
P365 SAS		10/12								•	5.8	4.1	1.0	3.1	NA	17.8	
P365XL		12/15								•	6.6	4.8	1.1	3.7	5.6	20.7	
P365XL RXZ		12/15								•	6.6	5.5	1.1	3.7	5.6	20.7	

RIFLE SPECIFICATIONS

Rifle Models	Caliber	Action Type	Operating System	Stock Type	Forend Type	Weight w/o Mag	Overall Length	Collapsed Length	Folded Length	Barrel Length	Rifling	Trigger Type	Mag Type	Mag Capacity
SIG MCX VIRTUS														
SIG MCX VIRTUS PATROL	5.56 NATO	Semi-Auto	Gas Piston, Rotating Bolt	Tele/Fold 5-Position	Free-Float M-LOK*	7.9 lb	35.5"	N/A	26.5"	16.0"	1:7	2-Stage Match	AR-15 Type	30
PMCX with PCB 11.5"	5.56 NATO	Semi-Auto	Gas Piston, Rotating Bolt	Fixed Folding PCB	Free-Float M-LOK*	7.4 lb	31.0"	N/A	22.0"	11.5"	1:7	2-Stage Match	AR-15 Type	30
PMCX with PCB 9"	300 BLK	Semi-Auto	Gas Piston, Rotating Bolt	Fixed Folding PCB	Free-Float M-LOK*	7.0 lb	28.5"	N/A	19.5"	9.0"	1:5	2-Stage Match	AR-15 Type	30
SIG MCX RATTLER														
SIG MCX RATTLER SBR	300 BLK	Semi-Auto	Gas Piston, Rotating Bolt	Fixed Folding	Free-Float M-LOK*	5.7 lb	23.5"	N/A	16"	5.5"	1:5	2-Stage Match	AR-15 Type	30
SIG MCX RATTLER SBR	5.56 NATO	Semi-Auto	Gas Piston, Rotating Bolt	Fixed Folding	Free-Float M-LOK*	5.7 lb	23.5"	N/A	16"	5.5"	1:7	2-Stage Match	AR-15 Type	30
SIG MCX RATTLER PCB	300 BLK	Semi-Auto	Gas Piston, Rotating Bolt	Fixed Folding PCB	Free-Float M-LOK*	5.7 lb	23.5"	N/A	16"	5.5"	1:5	2-Stage Match	AR-15 Type	30
SIG MCX RATTLER PCB	5.56 NATO	Semi-Auto	Gas Piston, Rotating Bolt	Fixed Folding PCB	Free-Float M-LOK*	5.7 lb	23.5"	N/A	16"	5.5"	1:7	2-Stage Match	AR-15 Type	30
SIG MCX RATTLER CANEBRAKE	300 BLK	Semi-Auto	Gas Piston, Rotating Bolt	Fixed Folding PCB	Free-Float M-LOK*	6.8 lb	29.0"	N/A	21"	5.5"	1:5	2-Stage Match	AR-15 Type	30
SIG MPX														
SIG MPX PCC	9MM	Semi-Auto	Gas Piston, Rotating Bolt	Tele/Fold 5-Position	Free-Float M-LOK*	6.6 lb	35.0"	N/A	25.0"	16.0"	1:10	Single Stage Timney	MPX	30
SIG MPX K PCB	9MM	Semi-Auto	Gas Piston, Rotating Bolt	Fixed Folding PCB	Alloy KeyMod	6.0 lb	22.5"	N/A	13.5"	4.5"	1:10	Single Stage Timney	MPX	30
SIG MPX COPPERHEAD PCB	9MM	Semi-Auto	Gas Piston, Rotating Bolt	N/A	N/A	4.5 lb	14.5"	N/A	N/A	3.5"	1:10	MIL-SPEC	MPX	20
SIG MPX COPPERHEAD K PCB	9MM	Semi-Auto	Gas Piston, Rotating Bolt	N/A	N/A	4.5 lb	22.3"	N/A	N/A	4.5"	1:10	MIL-SPEC	MPX	30
SIGM400														
SIGM400 TREAD	5.56 NATO	Semi-Auto	Direct Gas Impingement	6-Position Telescoping	Free-Float M-LOK*	6.5 lb	36.5"	N/A	N/A	16.0"	1:8	Hardened Polished	AR-15 Type	30
SIGM400 TREAD PISTOL	5.56 NATO	Semi-Auto	Direct Gas Impingement	Shockwave Brace	Free-Float M-LOK*	7.0 lb	38.0"	N/A	N/A	11.0"	1:9	2-Stage Match	AR-15 Type	5
SIG716G2														
SIG716 TREAD	7.62 NATO	Semi-Auto	Direct Gas Impingement	6-Position Telescoping	Free-Float M-LOK*	8.5 lb	37.0"	33.8"	N/A	16.0"	1:10	2-Stage Match	SR25 Type	20
SIG716 DMR G2	6.5 CM	Semi-Auto	Gas Piston, Rotating Bolt	6-Position Telescoping	Free-Float M-LOK*	8.8 lb	39.0"	33.8"	N/A	16.0"	1:9	2-Stage Match	SR25 Type	20
CROSS BOLT RIFLE														
CROSS BOLT	6.5 CM	Bolt Action	NA	SIG Precision Stock	Free-Float M-LOK*	6.4 lb	38.5"	36.5"	27"	18"	1:9	2-Stage Match	AI	5
CROSS BOLT	308 WIN 277 FURY	Bolt Action	NA	SIG Precision Stock	Free-Float M-LOK*	6.2 lb	36.5"	34.5"	25"	16"	1:10 /1:8.5	2-Stage Match	AI	5



SIG SAUER, Inc. • 72 Pease Boulevard • Newington, NH 03801 USA • +1 (603) 610-3000

An ISO 9001:2015 Registered Company. Manufacturing in the U.S.A.

sigsauer.com

MKT0008